

PVM-1910/1911

SERVICE MANUAL

US Model
Canadian Model

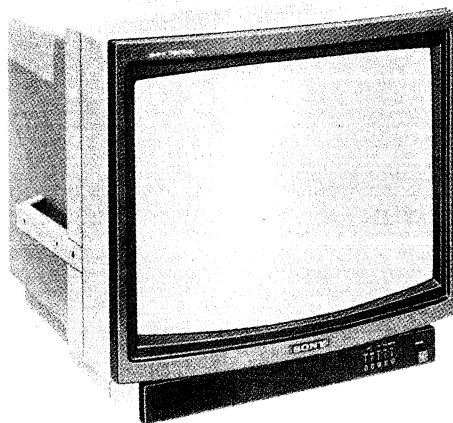

PVM-1910
Chassis No. SCC-554A-A

PVM-1911
Chassis No. SCC-556A-A

March, 1984

SPECIFICATIONS

Color system	NTSC system	Outputs	Loop through
Picture tube	Trinitron tube		VIDEO OUT: BNC connector
	19 inch picture measured diagonally,		AUDIO OUT: minijack
	100 degree deflection		EXT SYNC OUT: BNC connector
Resolution	350 TV lines, 440 × 240 dots		RGB OUT: BNC connectors
Color temperature	6,500°K/9,300°K	Audio output	AUDIO (RGB) OUT: minijack
Frequency response	8 MHz (-3 dB, RGB)	Power requirement	1.5 W
	6 MHz (-3 dB, composite video)	Power consumption	120 V ac, 60 Hz
Horizontal linearity	±5%	Dimensions	120 W (max.)
Vertical linearity	±5%		Approx. 486 × 463 × 539 mm (w/h/d)
Line pull range	Horizontal ±500 Hz		(19 ¹ / ₄ × 18 ¹ / ₄ × 21 ¹ / ₄ inches)
	Vertical 8 Hz	Weight	PVM-1910: Approx. 29 kg (63 lbs 15 oz)
Overscan of the picture	5%		PVM-1911: Approx. 30 kg (66 lbs 2 oz)
Return loss	4 MHz, 35 dB (LINE A, LINE B)	Optional accessories	Monitor stand SU-530
Zooming	Within 2%		Monitor hood VF-500
Convergence	Central area 1 mm		Design and specifications subject to change without notice.
	Outside of central area 1.3 mm		
Brightness	More than 50 foot-Lamberts		
Inputs	TUNER: 6-pin-DIN connector		
	VIDEO IN: BNC connector		
	VTR: 8-pin connector (pins 2 and 6)		
	Composite 1 V p-p ±6 dB, sync negative,		
	75 ohms and high impedance switchable		
	AUDIO IN: minijack		
	VTR: 8-pin connector (pins 1 and 5)		
	-5 dBs high impedance		
	EXT SYNC IN: BNC connector		
	Composite sync 2 - 8 V p-p, negative,		
	75 ohms and high impedance switchable		
	RGB IN: BNC connectors		
	0.7 V p-p, non composite		
	AUDIO (RGB) IN: minijack		
	-5 dBs high impedance		

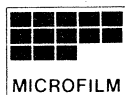

TRINITRON®
COLOR VIDEO MONITOR
SONY®

MON

TABLE OF CONTENTS

<u>Section</u>	<u>Title</u>	<u>Page</u>
1. GENERAL		
1-1.	Features	4
1-2.	Precautions	4
1-3.	Location and Function of Parts and Controls	5
1-4.	System Connections	6
2. DISASSEMBLY 11		
3. SETUP ADJUSTMENTS		
3-1.	Beam Landing	15
3-2.	Convergence	16
3-3.	Focus (RV713)	16
3-4.	White Balance	16
4. CIRCUIT ADJUSTMENTS		
4-1.	B Board Adjustments	18
4-2.	D Board Adjustments	21
4-3.	Safety Related Adjustments	22
4-4.	Q Board Adjustments	25
5. DIAGRAMS		
5-1.	Circuit Boards Location	29
5-2.	Block Diagram	29
5-3.	Semiconductors	32
5-4.	Schematic Diagram	33
5-5.	Printed Wiring Boards	41
5-6.	Waveforms	50
5-7.	Printed Wiring Boards (PVM-1911 Only)	52
5-8.	Semiconductors (PVM-1911 Only)	52
5-9.	Schematic Diagram (PVM-1911 Only)	55
6. EXPLODED VIEWS		
1.	Cabinet Ass'y	59
2.	Chassis Ass'y	60
3.	Bezel Ass'y	61
7. ELECTRICAL PARTS LIST 62		

SAFETY-RELATED COMPONENT WARNING !!

COMPONENTS IDENTIFIED BY SHADING AND MARK  ON THE SCHEMATIC DIAGRAMS, EXPLODED VIEWS AND IN THE PARTS LIST ARE CRITICAL TO SAFE OPERATION. REPLACE THESE COMPONENTS WITH SONY PARTS WHOSE PART NUMBERS APPEAR AS SHOWN IN THIS MANUAL OR IN SUPPLEMENTS PUBLISHED BY SONY. CIRCUIT ADJUSTMENTS THAT ARE CRITICAL TO SAFE OPERATION ARE IDENTIFIED IN THIS MANUAL. FOLLOW THESE PROCEDURES WHENEVER CRITICAL COMPONENTS ARE REPLACED OR IMPROPER OPERATION IS SUSPECTED.

ATTENTION AU COMPOSANT AYANT RAPPORT A LA SÉCURITÉ!!

LES COMPOSANTS IDENTIFIÉS PAR UN TRAMÉ ET UNE MARQUE  SUR LES DIAGRAMMES SCHÉMATIQUES, LES VUES EXPLOSÉES ET LA LISTE DES PIÈCES SONT CRITIQUES POUR LA SÉCURITÉ DE FONCTIONNEMENT. NE REMPLACER CES COMPOSANTS QUE PAR DES PIÈCES SONY DONT LES NUMÉROS SONT DONNÉS DANS CE MANUEL OU DES SUPPLÉMENTS PUBLIÉS PAR SONY. LES REGLAGES DU CIRCUIT QUI SONT CRITIQUES POUR LA SÉCURITÉ DE FONCTIONNEMENT SONT IDENTIFIÉS DANS CE MANUEL. SUIVRE LES PROCÉDURES QUAND LES COMPOSANTS CRITIQUES SONT REMPLACÉS OU LE FONCTIONNEMENT IMPROPRE EST SUSPECTÉ.

SAFETY CHECK-OUT

After correcting the original service problem, perform the following safety checks before releasing the set to the customer:

1. Check the area of your repair for unsoldered or poorly-soldered connections. Check the entire board surface for solder splashes and bridges.
2. Check the interboard wiring to ensure that no wires are "pinched" or contact high-wattage resistors.
3. Check that all control knobs, shields, covers, ground straps, and mounting hardware have been replaced. Be absolutely certain that you have replaced all the insulators.
4. Look for unauthorized replacement parts, particularly transistors, that were installed during a previous repair. Point them out to the customer and recommend their replacement.
5. Look for parts which, though functioning, show obvious signs of deterioration. Point them out to the customer and recommend their replacement.
6. Check the line cord for cracks and abrasion. Recommend the replacement of any such line cord to the customer.
7. Check the condition of the monopole antenna (if any). Make sure the end is not broken off, and has the plastic cap on it. Point out the danger of impalement on a broken antenna to the customer, and recommend the antenna's replacement.
8. Check the B+ and HV to see they are at the values specified. Make sure your instruments are accurate; be suspicious of your HV meter if sets always have low HV.
9. Check the antenna terminals, metal trim, "metallized" knobs, screws, and all other exposed metal parts for AC leakage. Check leakage as described below.

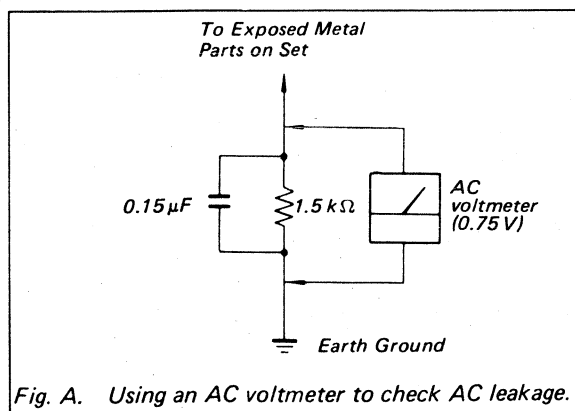

LEAKAGE TEST

The AC leakage from any exposed metal part to earth ground and from all exposed metal parts to any exposed metal part having a return to chassis, must not exceed 0.5 mA (500 microamperes). Leakage current can be measured by any one of three methods.

1. A commercial leakage tester, such as the Simpson 229 or RCA WT-540A. Follow the manufacturers' instructions to use these instruments.
2. A battery-operated AC milliammeter. The Data Precision 245 digital multimeter is suitable for this job.
3. Measuring the voltage drop across a resistor by means of a VOM or battery-operated AC voltmeter. The "limit" indication is 0.75 V, so analog meters must have an accurate low-voltage scale. The Simpson 250 and Sanwa SH-63Trd are examples of a passive VOM that is suitable. Nearly all battery operated digital multimeters that have a 2V AC range are suitable. (See Fig. A)

HOW TO FIND A GOOD EARTH GROUND

A cold-water pipe is guaranteed earth ground; the cover-plate retaining screw on most AC outlet boxes is also at earth ground. If the retaining screw is to be used as your earth-ground, verify that it is at ground by measuring the resistance between it and a cold-water pipe with an ohmmeter. The reading should be zero ohms. If a cold-water pipe is not accessible, connect a 60-100 watt trouble light (not a neon lamp) between the hot side of the receptacle and the retaining screw. Try both slots, if necessary, to locate the hot side of the line, the lamp should light at normal brilliance if the screw is at ground potential. (See Fig. B)

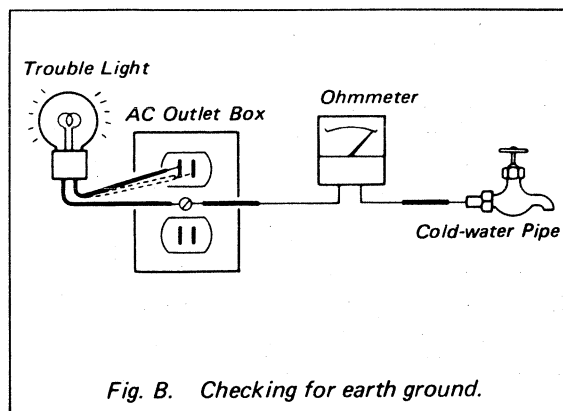

SECTION 1 GENERAL

1-1. FEATURES

PVM-1910 and PVM-1911

- **Colorpure Filter:** Fine picture detail without color spill or color noise can be obtained by setting the COMB FILTER select switch to COMB.
- **Automatic Frequency Control:** The horizontal AFC time constant is selected by setting this switch to either the fast or slow mode.
- **LINE A/LINE B/VTR/RGB/CMPTR:** Selects the inputs.
- **TUNER:** Permits connection of the special color TV tuner with a single connecting cable.
- **Superimposed Picture:** When utilizing the SMI-7073 superimposer (optional) and a microcomputer, the pictures from a videodisc player and a microcomputer can be superimposed.

PVM-1911

- **Touch screen and controller:** A screen address can be obtained by touching the desired position on the screen with a finger.

1-2. PRECAUTIONS

On safety

- Check that the operating voltage of your unit is identical with the voltage of your local power supply.
- Should any liquid or solid object fall into the cabinet, unplug the unit and have it checked by qualified personnel before operating it any further.
- Unplug the unit from the wall outlet if it is not to be used for several days.
- To disconnect the ac power cord, pull it out by the plug. Never pull the cord itself.

On installation

- Allow adequate air circulation to prevent internal heat build-up. Do not place the unit on surfaces (rugs, blankets, etc.) or near materials (curtains, draperies) that may block the ventilation holes.
- Do not install the unit in a location near heat sources such as radiators or air ducts, or in a place subject to direct sunlight, excessive dust, mechanical vibration or shock.

On cleaning

- To keep the unit looking brand-new, periodically clean it with a soft cloth. Stubborn stains may be removed with a cloth lightly dampened with a mild detergent solution. Never use strong solvents such as thinner or benzene, or abrasive cleansers since these will damage the cabinet. As a safety precaution, unplug the unit before cleaning it.
- To clean the screen, the frame and the screen shield may be removed as follows.

- 1** Remove the screws with a coin or similar object.

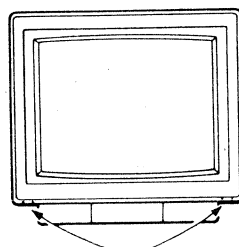

- 2** Remove the frame.

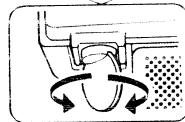
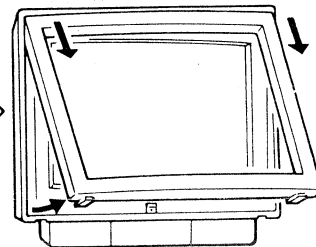

- 4** PVM-1910: Remove the screen shield.
PVM-1911: Open the screen shield.

Hold the shield open while cleaning the screen. Be careful not to pull out the right side of the shield because the cords connected there may be damaged.

- 3** Remove the screws with a screwdriver.

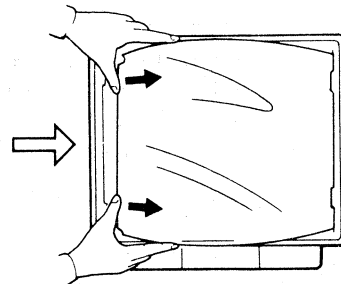
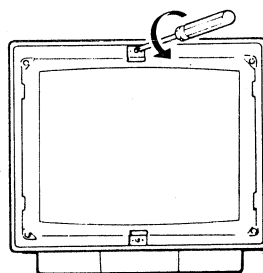

On repacking

Do not throw away the carton and packing materials. They make an ideal container in which to transport the unit. When shipping the unit to another location, repack it as illustrated on the carton.

If you have any questions about this unit, contact your Sony service facility.

1-3. LOCATION AND FUNCTION OF PARTS AND CONTROLS

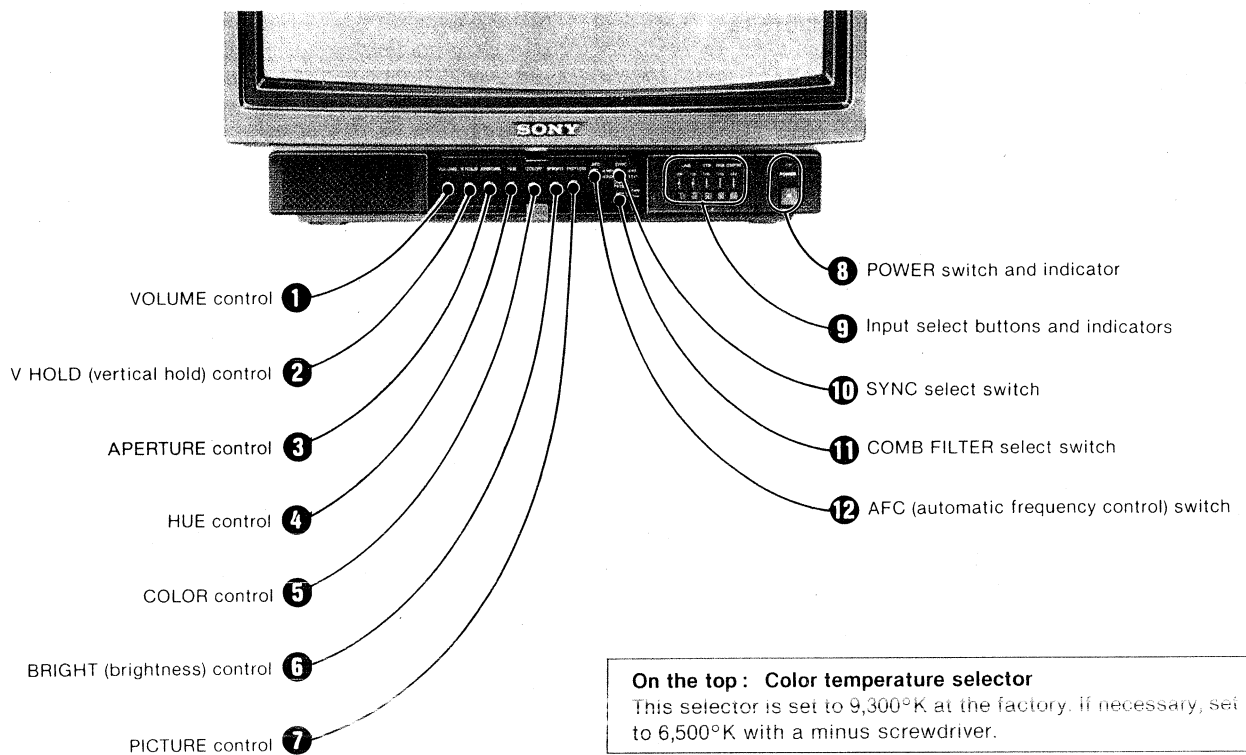

1 VOLUME control

Turn this control clockwise or counterclockwise to obtain the desired volume.

2 V HOLD (vertical hold) control

If the picture rolls vertically, correct it with this control.

3 APERTURE control

Adjusts the sharpness of the picture. When the control is turned all the way to the left, the picture will have normal control. If reception conditions result in a snowy picture, better results will be obtained with a softer picture.

4 HUE control

Use to obtain the most natural skin tones. Clockwise rotation makes the skin tones greenish; counterclockwise rotation makes them purplish.

5 COLOR control

Adjusts the color intensity of the picture. Clockwise rotation makes the picture vivid; counterclockwise rotation makes it pale.

6 BRIGHT (brightness) control

Adjusts the brightness. Normally set this control at the center detent position.

7 PICTURE control

Adjusts the contrast, color intensity and brightness simultaneously in the proper ratio.

8 POWER switch and indicator

To turn the monitor on, depress the POWER switch. The indicator will light. To turn the monitor off, press the switch again.

9 Input selector buttons and indicators

Press to select the program to be monitored. LINE A: for a signal from the LINE A (VIDEO/AUDIO or TUNER) (TUNER) connectors.

LINE B: for a signal from the LINE B connectors.

VTR: for a signal from the 8-pin VTR connector.

RGB: for a signal from the R, G, B and AUDIO (RGB) connectors.

CMPTR: for a signal from the 25-pin CMPTR connector.

When an input select button is pressed, the indicator above the button will light up.

10 SYNC select switch

Sync may be supplied from an external sync generator to the EXT SYNC IN connector on the rear panel. When an external SYNC is supplied with either composite or non-composite video input, release the SYNC SELECT SWITCH (EXT). When composite video is supplied without external sync, depress the SYNC select switch (INT).

11 COMB FILTER select switch

Keep this switch depressed (COMB) during normal use to obtain fine picture detail without color spill or color noise. When a microcomputer, such as the APPLE II, is connected and stripes appear, release this switch (TRAP).

12 AFC (automatic frequency control) switch

Select the AFC operation in the fast mode or slow mode.

FAST: incoming sync timing errors are compensated for.

SLOW: incoming sync timing errors are displayed on the screen.

This mode is used to monitor the jitter from the VTR.

1-4. SYSTEM CONNECTION

CONNECTORS FOR VIDEO/AUDIO/MICROCOMPUTER

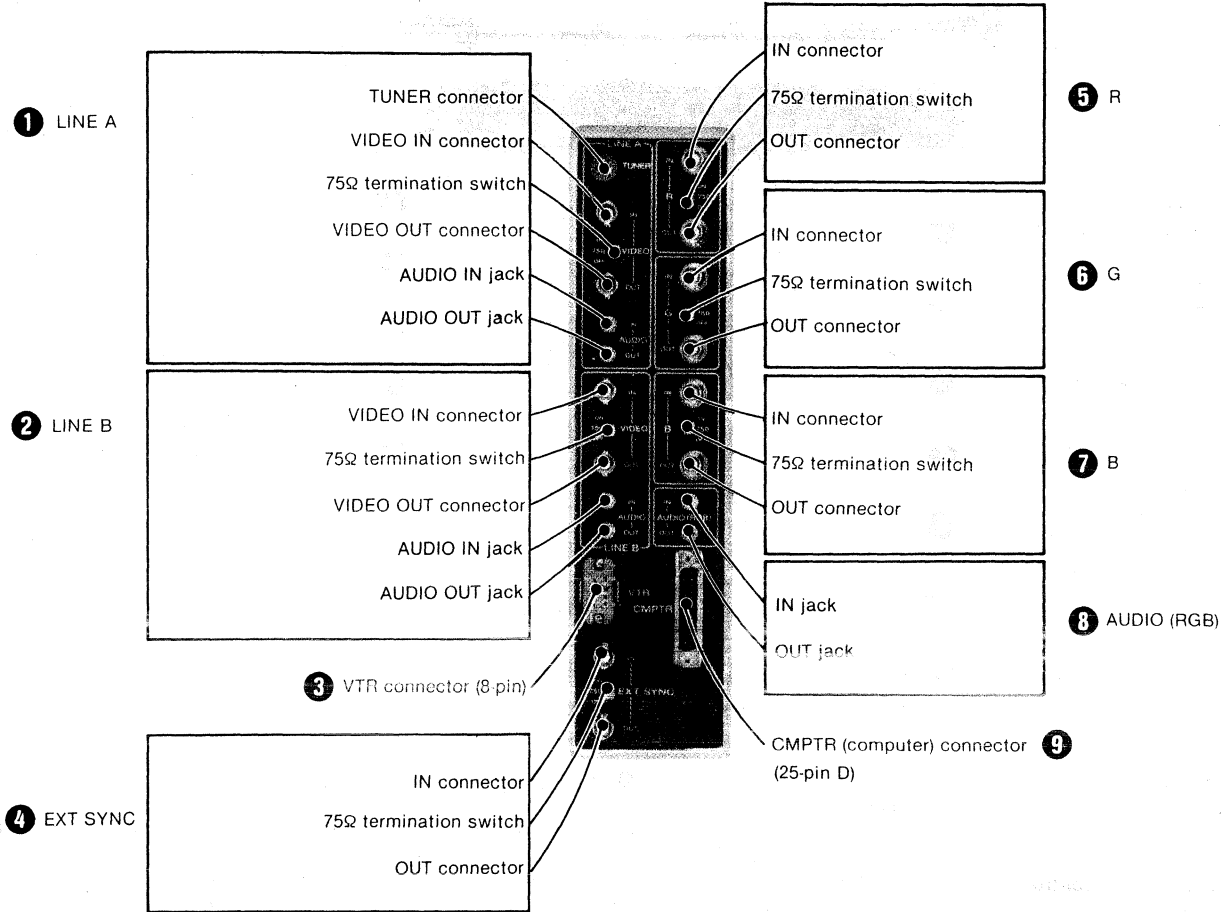

1 LINE A 2 LINE B

Press the LINE A or LINE B input select button to monitor the signal.

TUNER connector (BNC)

Connect to the output connector on the Special color TV tuner with the connecting cable supplied with the tuner. The video and audio signals and power can be connected simultaneously with this cable. When the tuner is connected to this connector, the VIDEO IN/OUT connectors and the AUDIO IN/OUT connectors of LINE A cannot be used. Press the LINE A input select switch to monitor the signal from a color TV tuner.

VIDEO IN connectors (BNC)

Connect to the video output of a video tape recorder or another monitor (for loop through connection), or to a color camera.

75Ω termination switches

When only one monitor is used, set the switch to ON. When several monitors are connected, set the switch of the last monitor in the looped chain to ON and set it to OFF on the other monitors.

VIDEO OUT connectors (BNC)

Connect to the video input of another monitor or a video tape recorder.

AUDIO IN jacks (minijack)

Connect to the audio output of a video tape recorder or another monitor (for loop through connection), or to a microphone using a suitable microphone amplifier.

AUDIO OUT jacks (minijack)

Connect to the audio input of another monitor or a video tape recorder.

3 VTR connector (8-pin)

Connect to a video tape recorder equipped with an 8-pin connector. For monitoring, press the VTR input select button.

For connection, use the optional video cable, VMC-3P(3 m), -5P(5 m), -10P(10 m), -25P(25 m) or -50P(50 m).

4 EXT SYNC IN connector (BNC)

Connect to an external sync generator.

75Ω termination switch

When equipment is connected to the EXT SYNC OUT connector, set the switch to OFF. When nothing is connected, set to ON.

OUT connector (BNC)

Supplies the external sync signal from the external sync generator connected to the EXT SYNC IN connector.

5 R 6 G 7 B**IN connectors (BNC)**

Allows a character generator, microcomputer or video camera having analog RGB outputs to be connected. Press the RGB input select button to monitor the signal.

75 Ω termination switches

When only one monitor is used, set the switch to ON. When several monitors are connected, set the switch of the last monitor in the looped chain to ON and set it to OFF on the other monitors.

OUT connectors (BNC)

Connect to the analog RGB inputs of another monitor.

8 AUDIO (RGB)**IN jack (minijack)**

Connect to the audio output of the equipment connected to the RGB IN connectors. Press the RGB input select button to monitor the signal.

OUT jack (minijack)

Connect to the RGB audio input of another monitor.

9 CMPTR (computer) connector (25-pin D)

Connect to a microcomputer with digital or analog RGB outputs. Press the CMPTR input select button to monitor the signal.

PVM-1910/1911

CONNECTING A COLOR TV TUNER

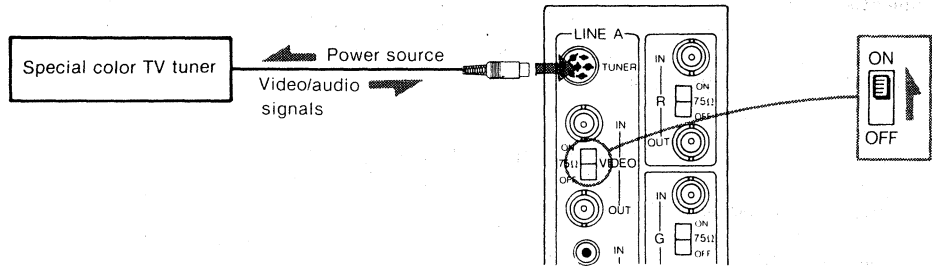

CONNECTING A VIDEO TAPE RECORDER

Note
When monitoring the picture at fast speed, the picture may roll vertically or become monochrome.

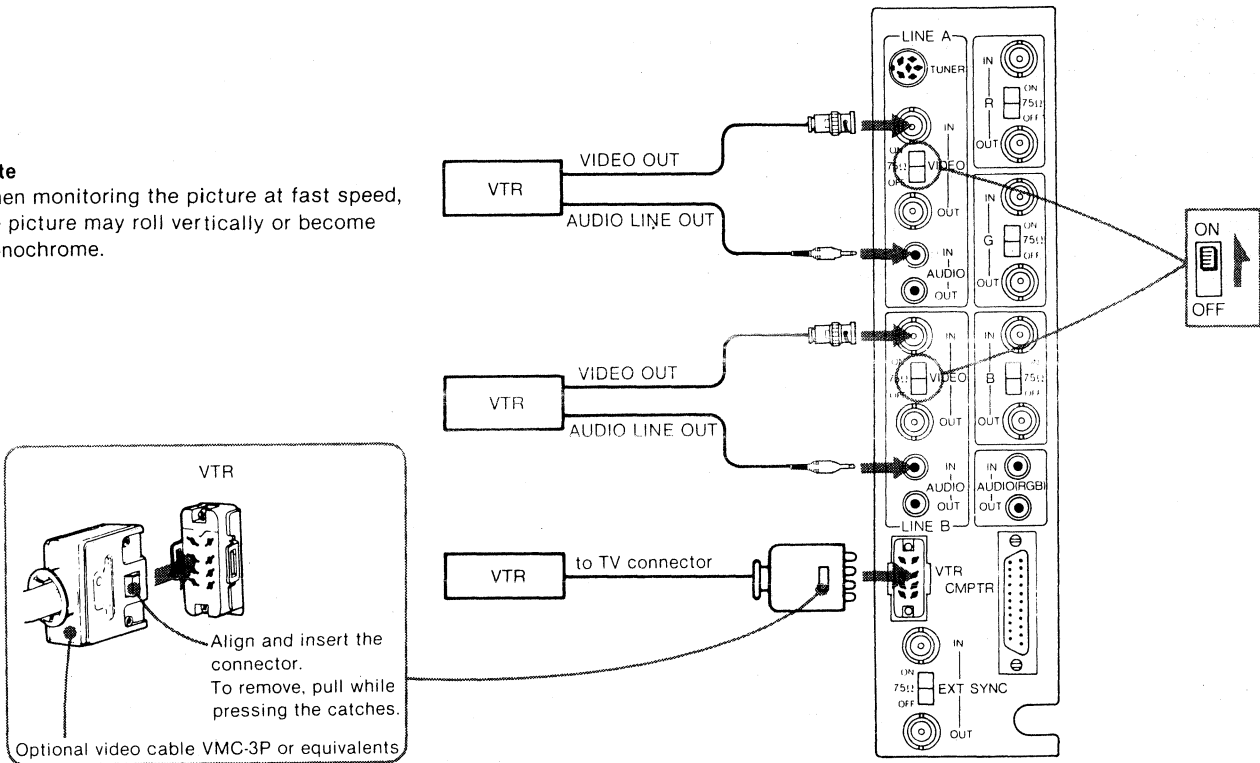

CONNECTING A VIDEO CAMERA

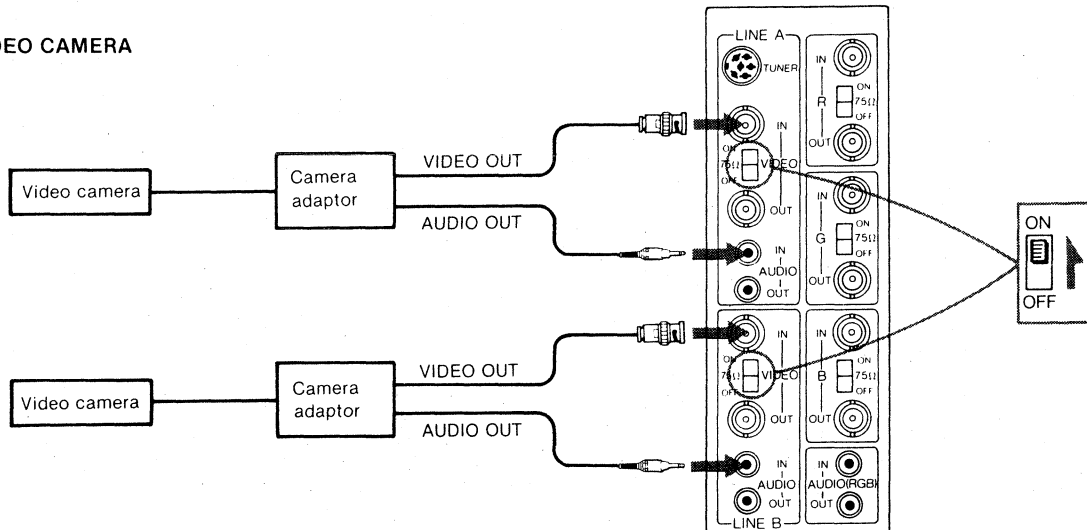

MULTIPLE MONITOR CONNECTION

Up to 10 monitors may be connected. Set the 75Ω termination switch of the last monitor to ON and that of the other monitors to OFF.

The LINE A or LINE B input select button on each monitor should be pushed in.

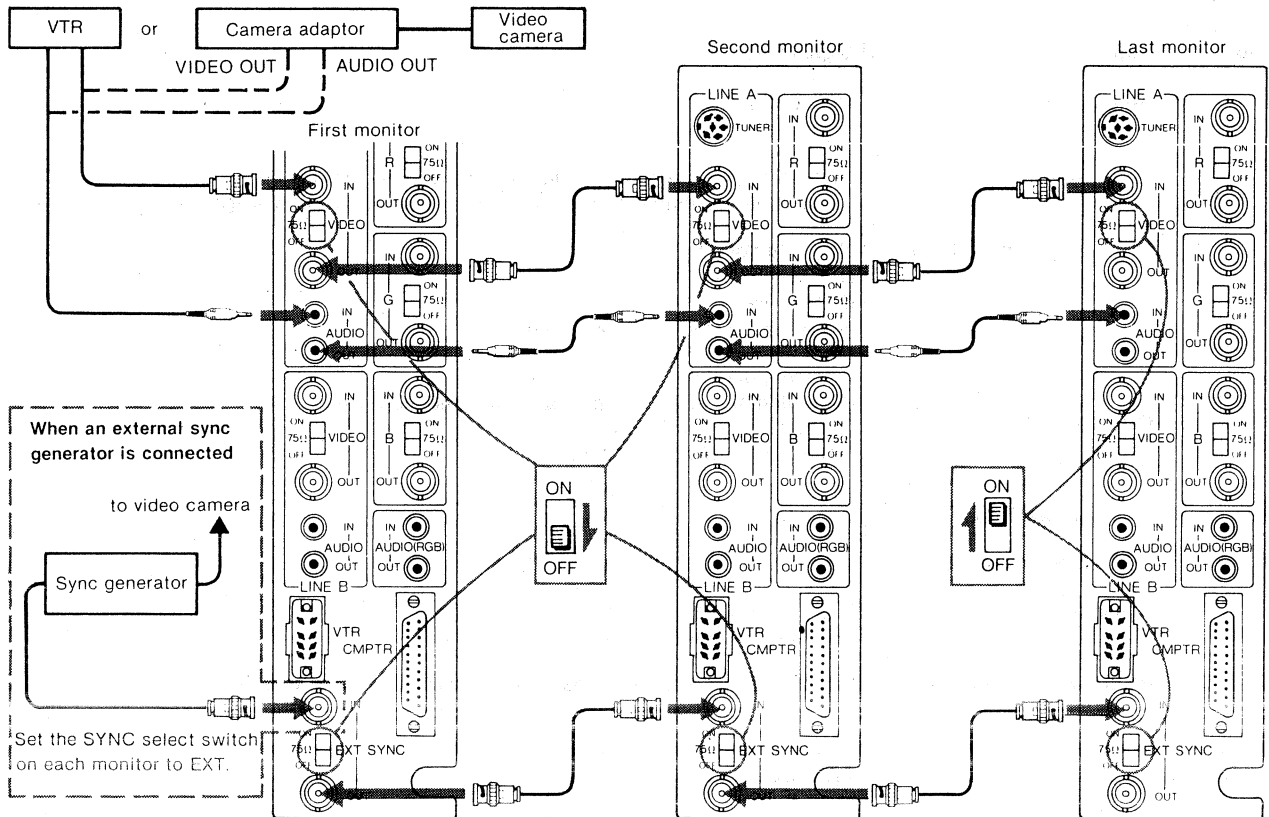

CONNECTING A MICROCOMPUTER

The CMPTR connector allows a microcomputer with digital or analog RGB outputs to be connected. The R, G and B IN connectors allow a microcomputer with analog RGB outputs to be connected.

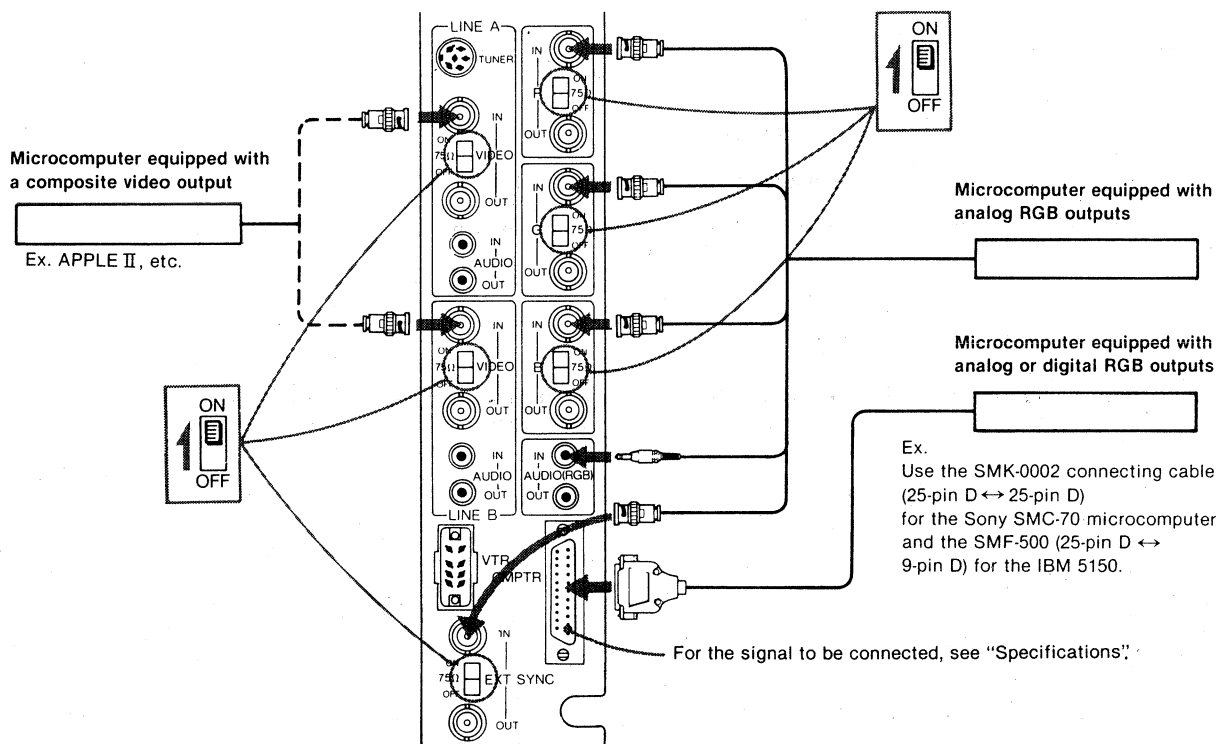

PVM-1910/1911

CMPTR : 25-pin D connector

Pin No.	Signal	Signal level
1	IBM select	High state (5 V) : IBM mode Low state : 3 Bit TTL
2	Audio select	High state (5 V or open) : audio inputs from the CMPTR connector Low state (less than 0.4 V) : audio inputs from the LINE A AUDIO IN jack
3	H. sync or composite sync	Negative polarity (1) 1 V p-p, 75Ω terminated (2) TTL level •(1) or (2) is selected by the pin 9.
4	Blue input	Positive polarity (1) Analog signal (0.7 V p-p, 75Ω terminated, non sync) (2) Digital signal (TTL level) •(1) or (2) is selected by the pin 9.
5	Green input	
6	Red input	
7	+ 12 V power supply	
8	+ 5 V power supply	
9	Analog/digital mode select	High state (open) : Analog signal (0.7 V p-p) Low state (ground) : Digital signal (TTL level)
10	RGB/NORMAL mode select	High state (5 V or open) : RGB inputs from the microcomputer Low state (ground) : composite video inputs from the LINE A VIDEO IN connector
11	V-sync	Negative polarity TTL level
12	Blanking	High state (5 V or open) : video inputs from the microcomputer Low state (ground) : Superimposed signal of composite video inputs from the LINE A VIDEO IN connector and the RGB inputs from the microcomputer

CMPTR : 25-pin D connector

Pin No.	Signal	Signal level
13	Audio input	Input level -5 dB (100% modulation), input impedance more than 47 kΩ
14	EXT/INT mode sync switch	High state (open) : microcomputer sync Low state : LINE A sync
15 1 24	ground	
25	IBM luminance signal	•Positive polarity, TTL level when the high state is selected at the pin 1. •Set to the low state (ground) when the low state is selected at the pin 1.

SECTION 2 DISASSEMBLY

(1) CABINET ASS'Y AND PICTURE TUBE REMOVAL

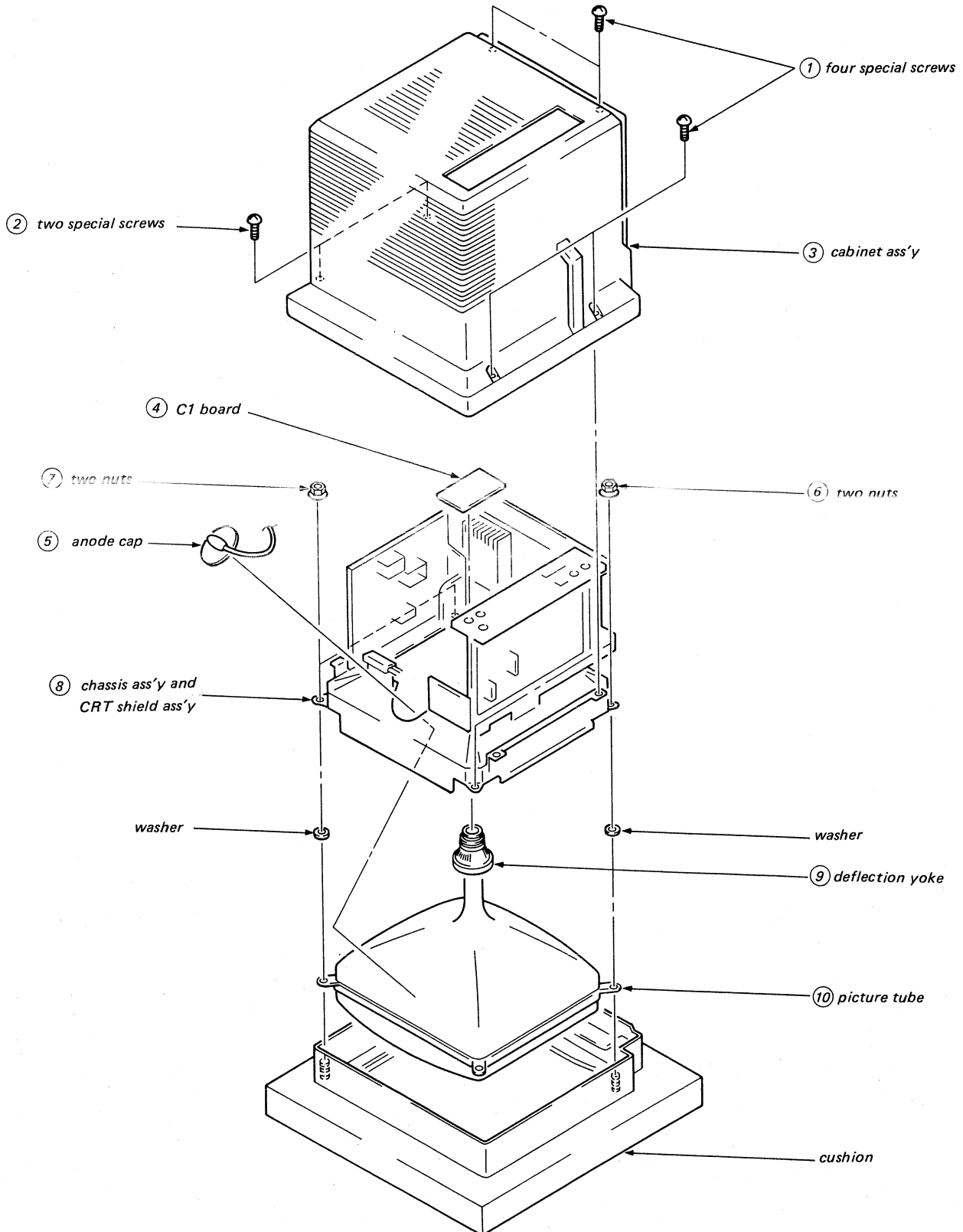

(2) FOR CHECKING B AND Q BOARD UP

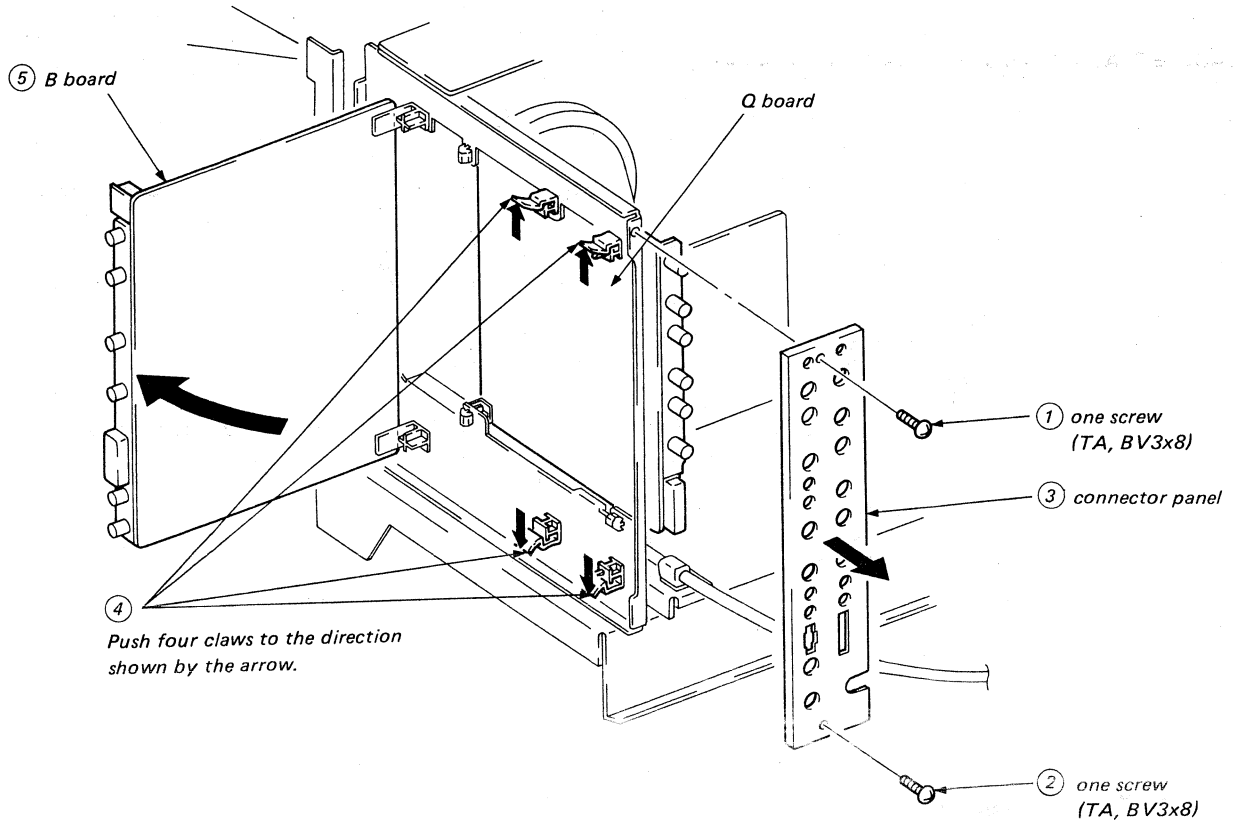

(3) F BOARD REMOVAL

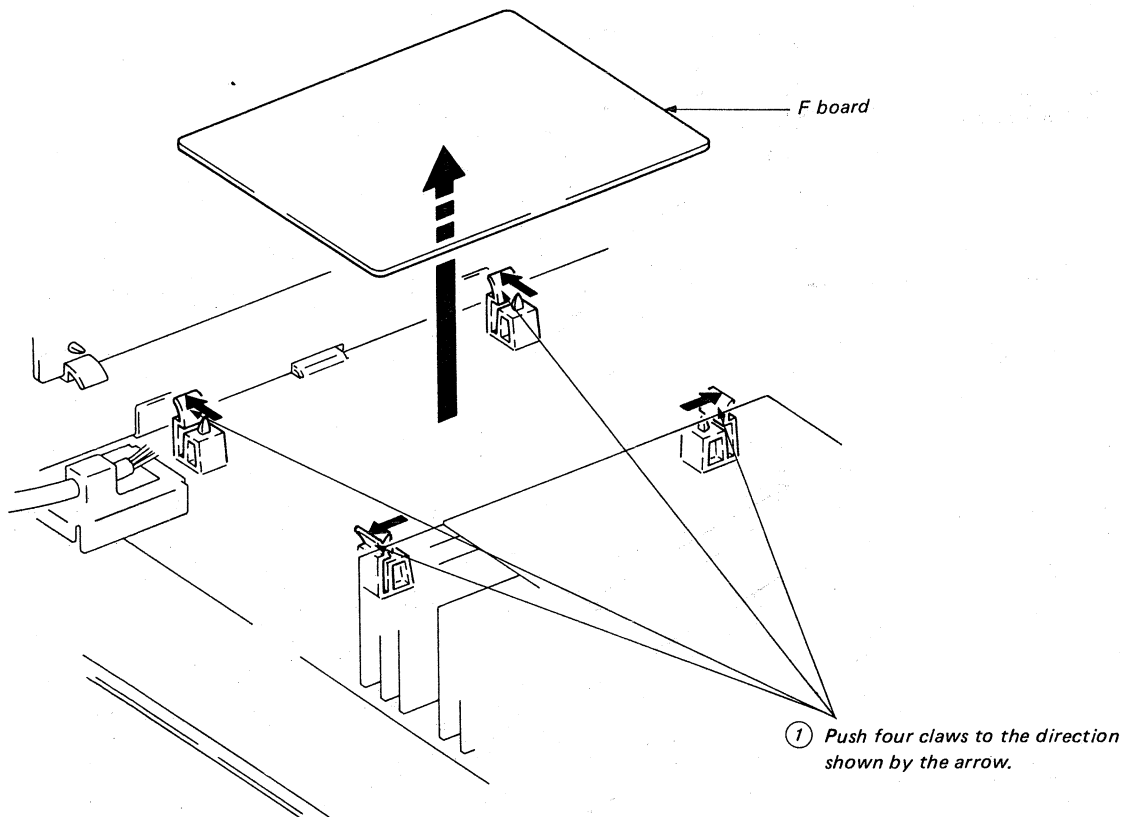

(4) SWITCHING REGULATOR REMOVAL ... (1)

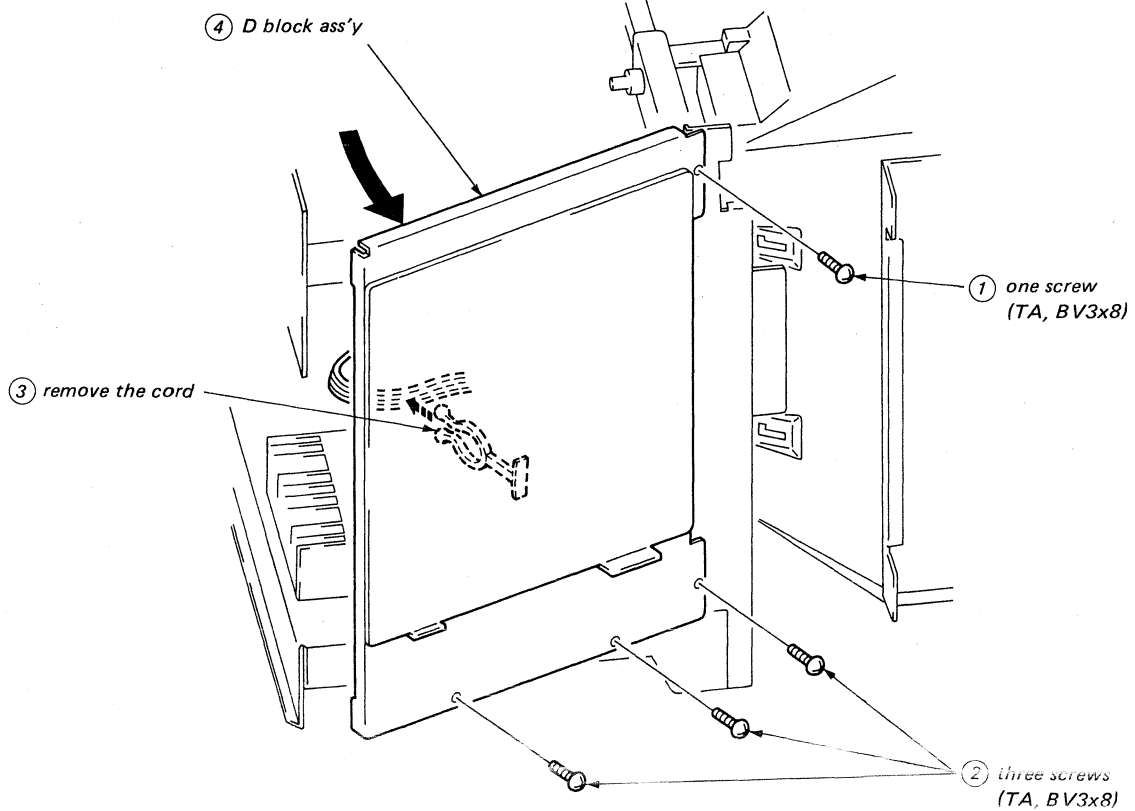

(5) SWITCHING REGULATOR REMOVAL ... (2)

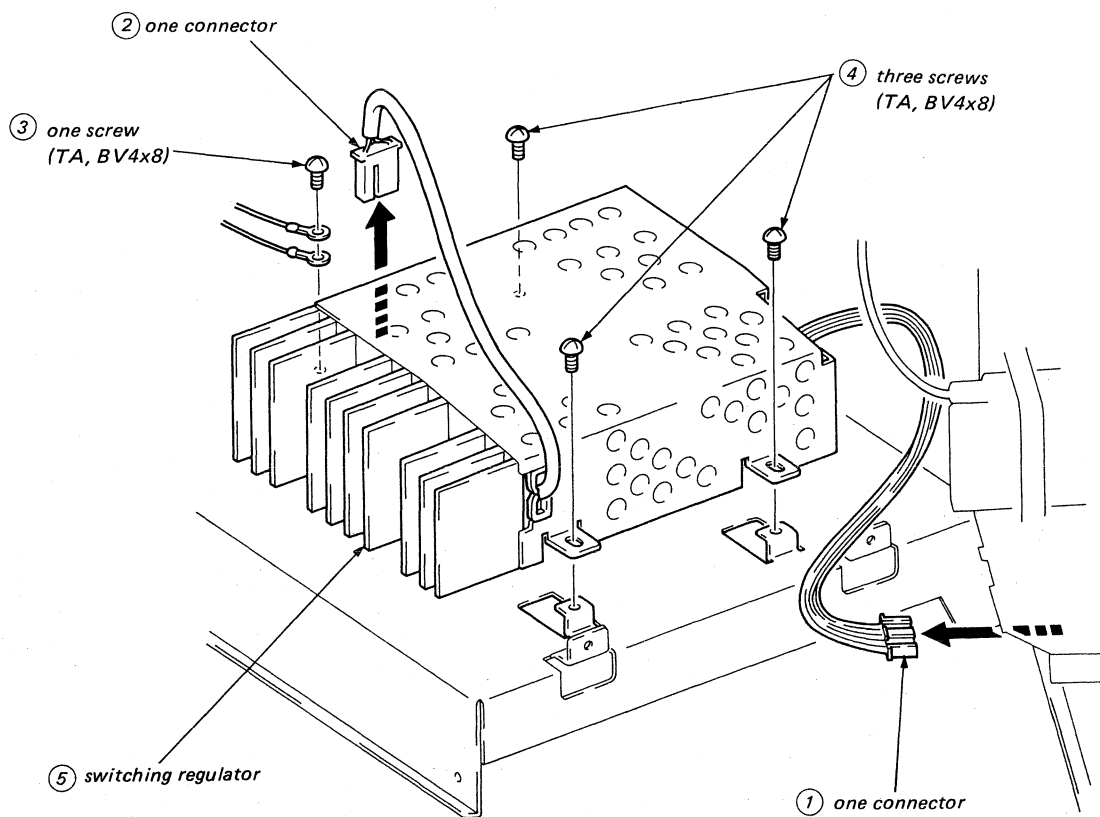

(6) H BOARD REMOVAL

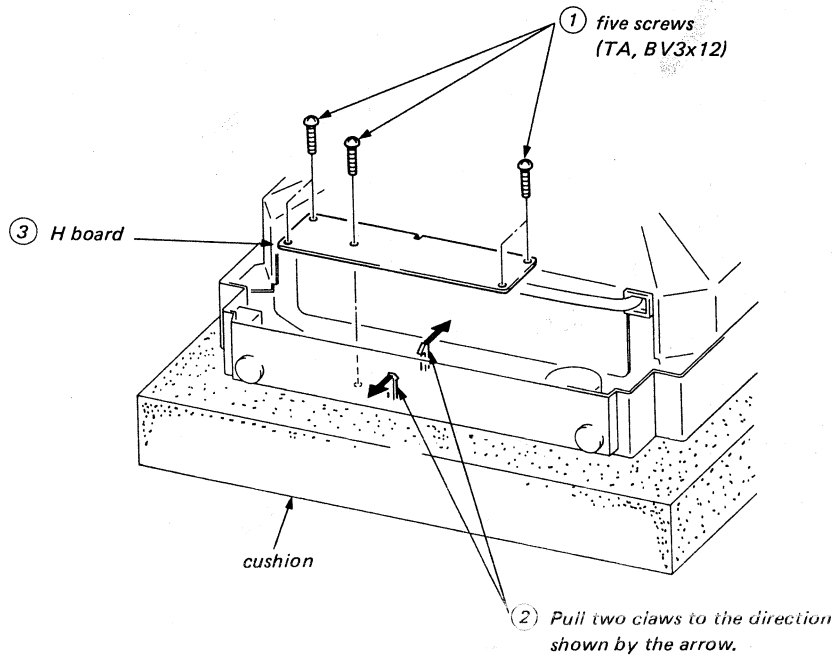

(7) M BOARD REMOVAL (PVM-1911 ONLY)

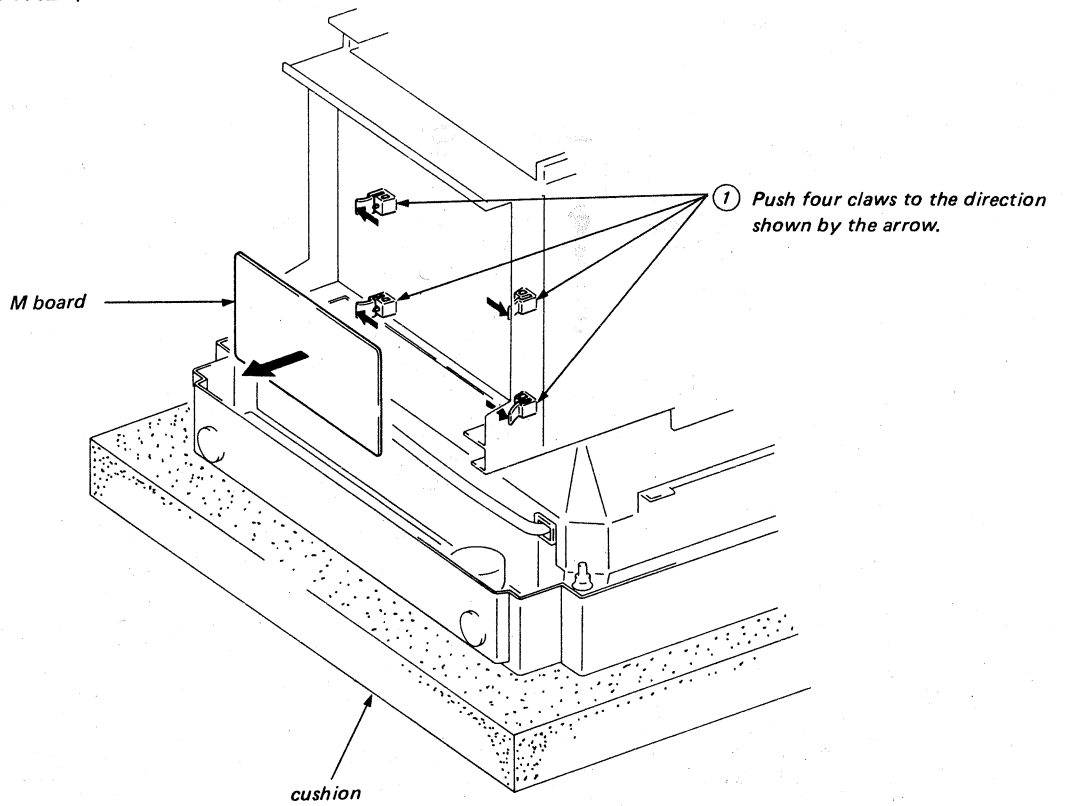

SECTION 3
SETUP ADJUSTMENTS

3-1. BEAM LANDING

Landing Adjustment In the case of a 6,500°K color temperature, the number of VRs to be adjusted will differ.

- (1) Turn on set power supply and receive and all-white signal.
- (2) Evenly degauss the entire screen.
- (3) Loosen the deflection yoke mounting screw, and set the purity control to the center as shown in Fig. 1-1.
- (4) Set BKG volume RV708 (G) to maximum and set RV712 (B) and RV704 (R) to minimum.
- (5) Move the deflection yoke back, and adjust the purity control so that (G) is in the center and (R) and (B) are at the sides, evenly. (Fig. 1-2)
- (6) Move the deflection yoke forward so that the entire screen is G.
- * If the deflection yoke is pushed all the way to the CRT then moved slightly back, landing adjustment is easier.
- (7) Substitute (R), then (B) for (G) in step (4) and check landing.
- (8) Rotate (R), (G) and (B) once each and check landing.
- (9) When landing is not right, adjust the purity control and use magnets as shown in Fig. 1-3, then repeat steps (7) and (8).
- (10) When a magnet is used, be sure to perform step (2), and tighten deflection yoke mounting screw loosely.

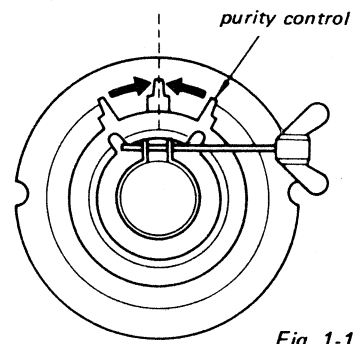

Fig. 1-1.

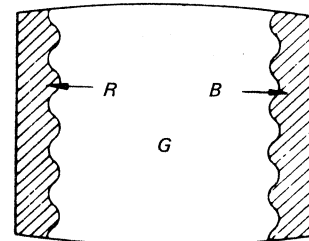

Fig. 1-2.

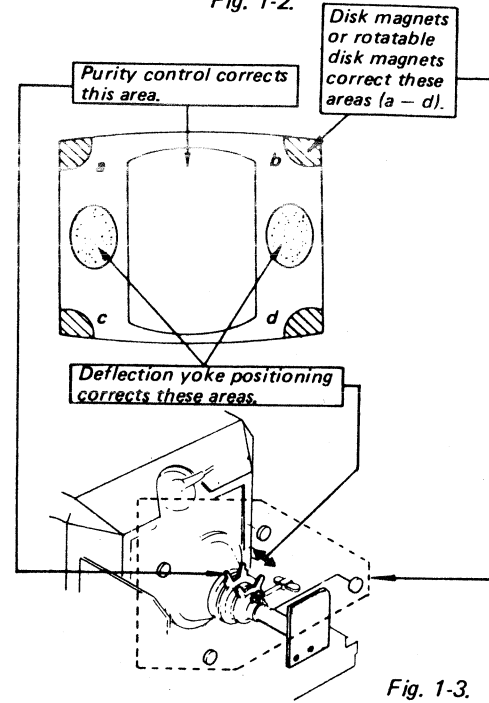
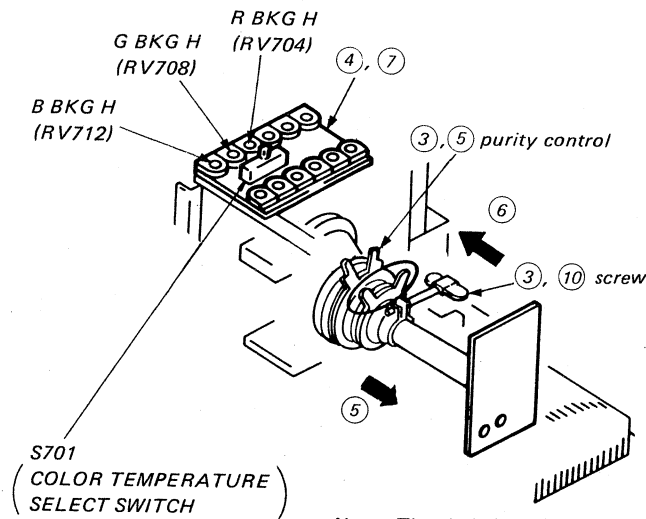

Fig. 1-3.



Note: The circled numbers (3-7) and (10) shown above steps.

3-2. CONVERGENCE

Preparation:

- Before starting, perform FOCUS, H.SIZE, V.SIZE and V.LIN adjustments.
- Set BRIGHTNESS control to fully counterclockwise.
- Feed in the dot pattern.

(1) Horizontal and Vertical Static Convergence

If blue dot does not coincide with red and green dots, perform following steps.

Move BMC magnet to correct insufficient H. static convergence.

Rotate BMC magnet to correct insufficient V. static convergence.

In either case, repeat Beam Landing Adjustment.

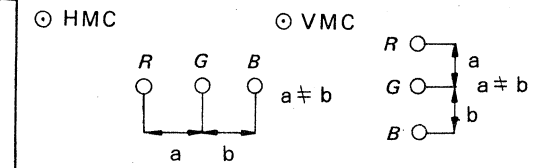
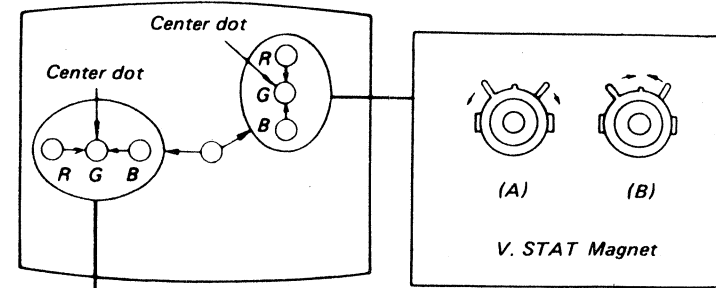

Adjust HMC



Adjust VMC

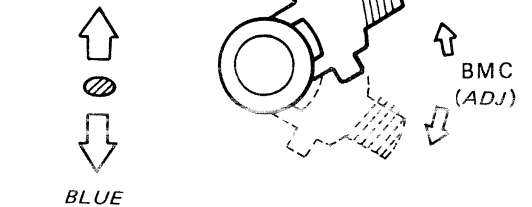

3-3. FOCUS(RV713)

- (1) Feed in monoscope signal, (PICTURE: 80%, BRIGHT: 50%)
- (2) Adjust RV713 for best Focus.

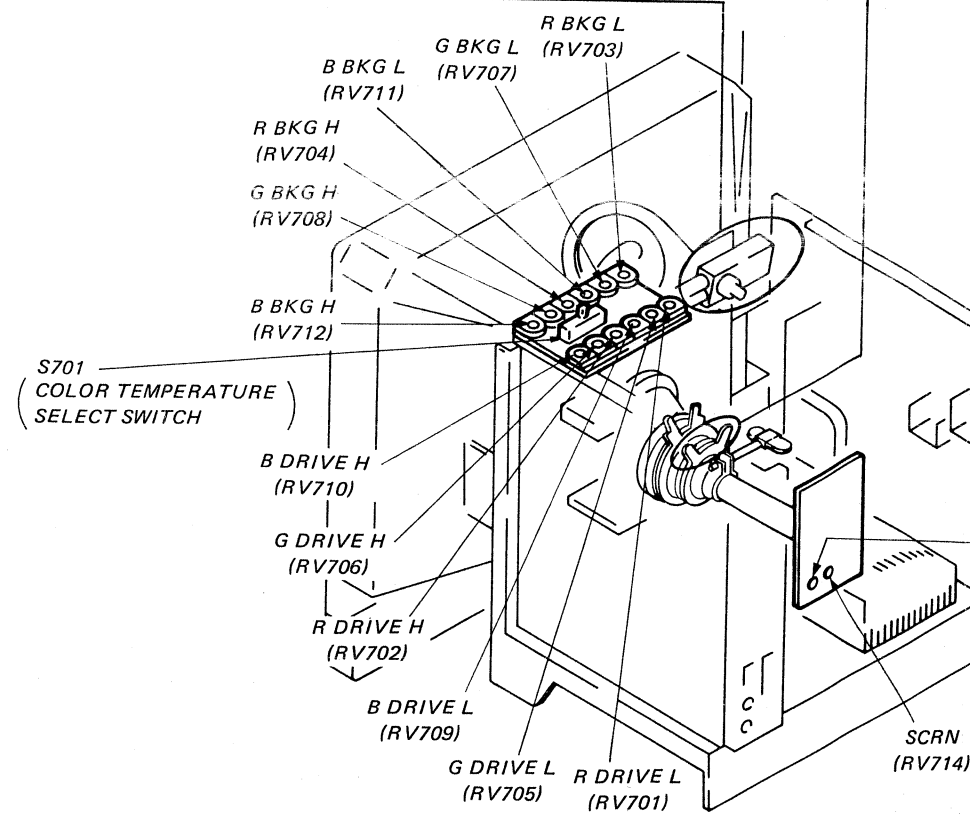

3-4. WHITE BALANCE

[For 9,300°K Color Temperature:]

- (1) Receive a totally white signal from the pattern generator.
- (2) Set BRIGHT at 50%, PICTURE at 80%, the various BKG VRs (RV704, 708, and 712) at 50%, and the various DRIVE VRs H (RV702, 706, and 710) at 80%.
- (3) Turn all the other BKG VRs than the one for the color that started glowing first, and adjust the white balance at cut-off.
- (4) Adjust the high light side white balance with drive VRs.

- (5) By turning other drive VRs than the one for the color glowing the brightest of all, adjust the white balance. Repeat operating steps (3) and (4).

[For 6,500°K Color Temperature:]

- (1) By turning BKG VRs (RV703, 707, and 711) and drive VRs (RV701, 705, and 709), make the same adjustment as in the 9,300°K color temperature mode.

3-2. CONVERGENCE

Preparation:

- Before starting, perform FOCUS, H.SIZE, V.SIZE and V.LIN adjustments.
- Set BRIGHTNESS control to fully counterclockwise.
- Feed in the dot pattern.

(1) Horizontal and Vertical Static Convergence

If blue dot does not coincide with red and green dots, perform following steps.

- Move BMC magnet to correct insufficient H. static convergence.
- Rotate BMC magnet to correct insufficient V. static convergence.

In either case, repeat Beam Landing Adjustment.

(2) Dynamic Convergence Adjustment

Preparation:

- Before starting, perform Horizontal and Vertical Static Convergence Adjustment.
1. Loosen deflection yoke screw.
 2. Remove deflection yoke spacers.
 3. Move the deflection yoke for best convergence as shown below.
 4. Tighten the deflection yoke screw.
 5. Install the deflection yoke spacers.

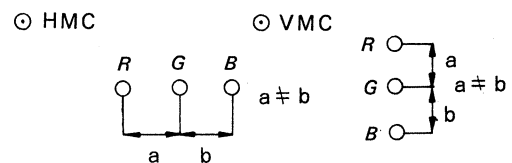
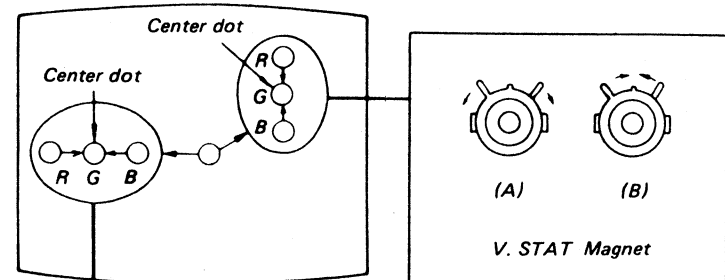

Adjust HMC



Adjust VMC

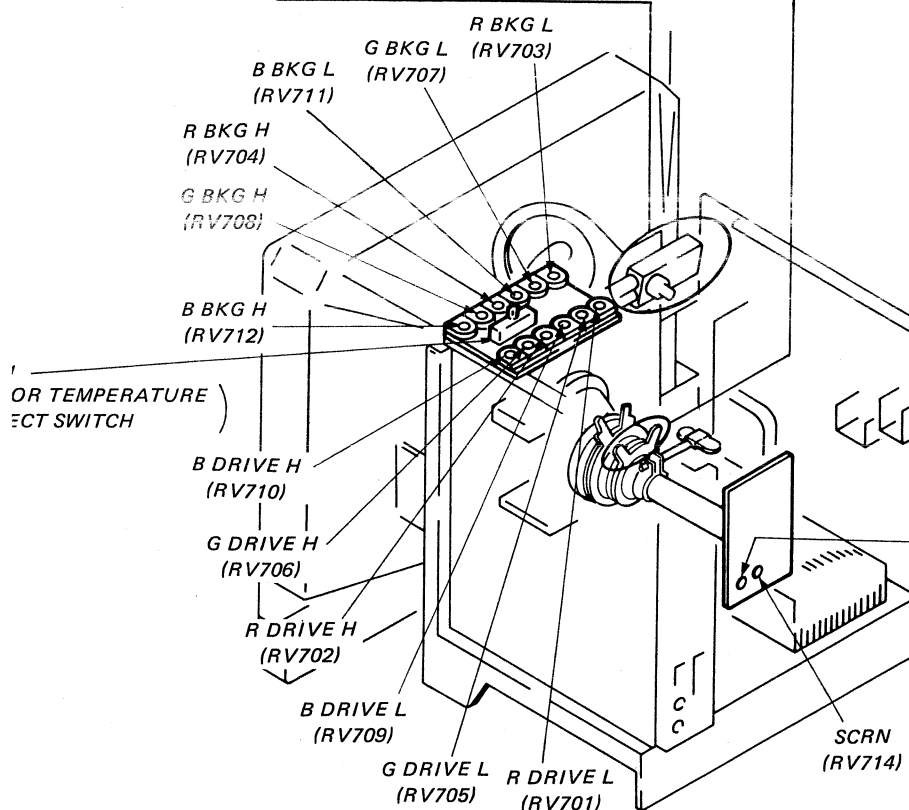
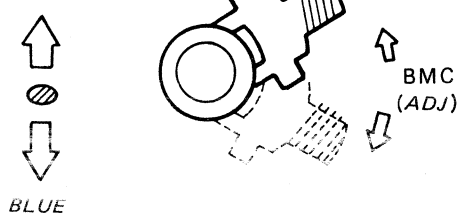

3-3. FOCUS (RV713)

- (1) Feed in monoscope signal, (PICTURE: 80%, BRIGHT: 50%)
- (2) Adjust RV713 for best Focus.

FOCUS (RV713)

3-4. WHITE BALANCE

[For 9,300° K Color Temperature:]

- (1) Receive a totally white signal from the pattern generator.
- (2) Set BRIGHT at 50%, PICTURE at 80%, the various BKG VRs (RV704, 708, and 712) at 50%, and the various DRIVE VRsH (RV702, 706, and 710) at 80%.
- (3) Turn all the other BKG VRs than the one for the color that started glowing first, and adjust the white balance at cut-off.
- (4) Adjust the high light side white balance with drive VRs.

- (5) By turning other drive VRs than the one for the color glowing the brightest of all, adjust the white balance. Repeat operating steps (3) and (4).

[For 6,500° K Color Temperature:]

- (1) By turning BKG VRs (RV703, 707, and 711) and drive VRs (RV701, 705, and 709), make the same adjustment as in the 9,300° K color temperature mode.

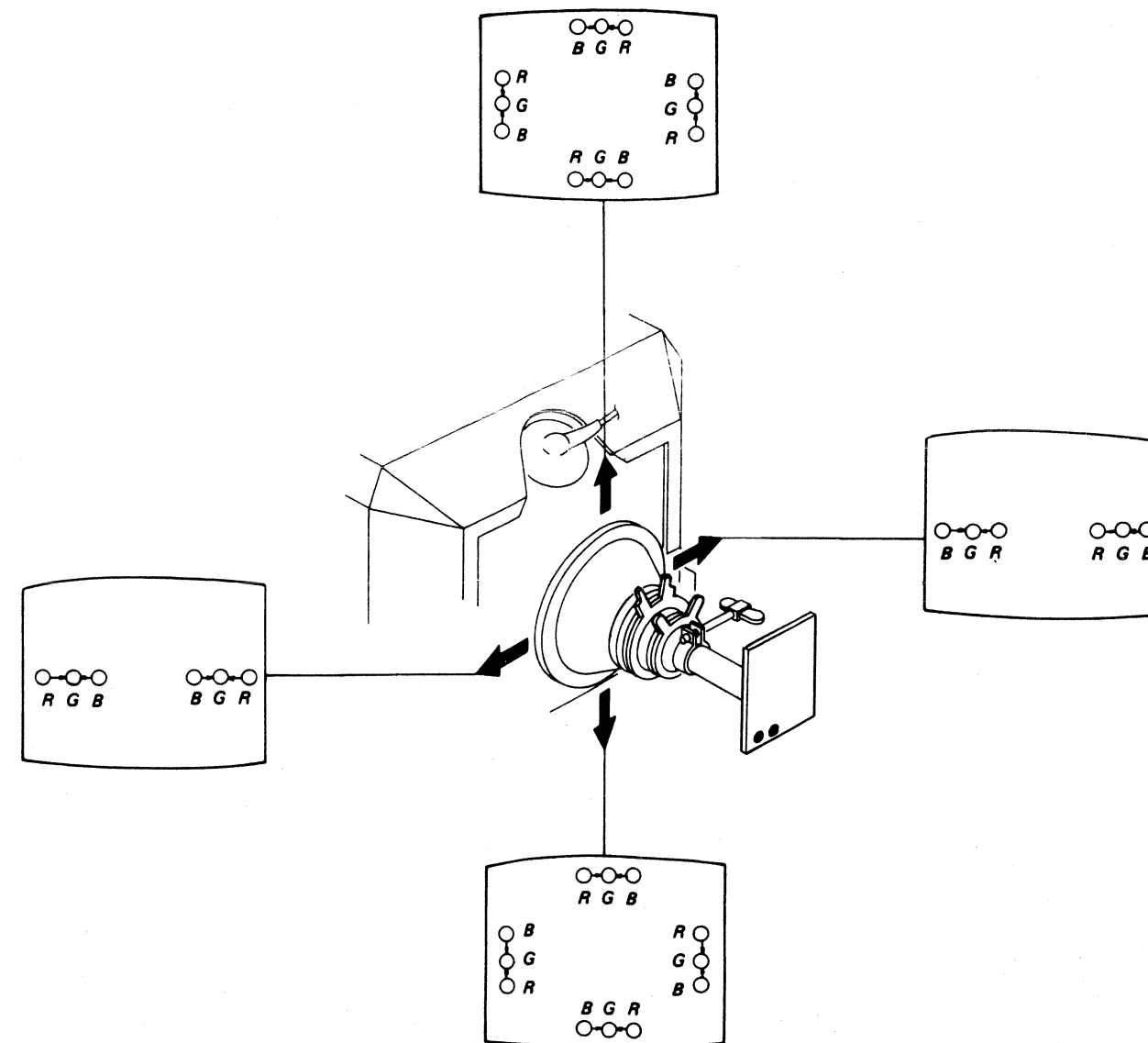

4-1. B BOARD ADJUSTMENTS

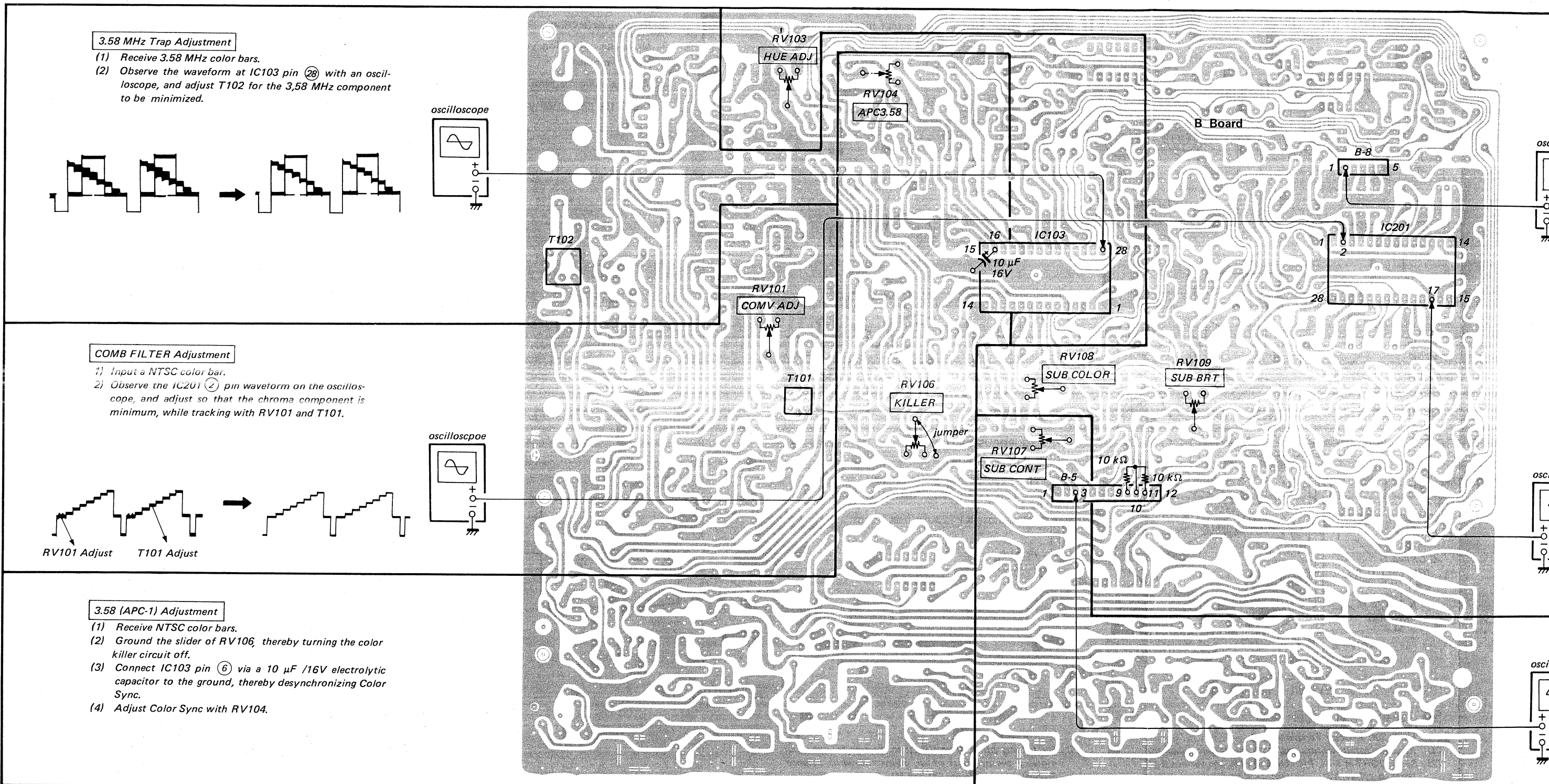

3.58 MHz Trap Adjustment

- (1) Receive 3.58 MHz color bars.
- (2) Observe the waveform at IC103 pin 28 with an oscilloscope, and adjust T102 for the 3.58 MHz component to be minimized.



COMB FILTER Adjustment

- 1) Input a NTSC color bar.
- 2) Observe the IC201 2 pin waveform on the oscilloscope, and adjust so that the chroma component is minimum, while tracking with RV101 and T101.

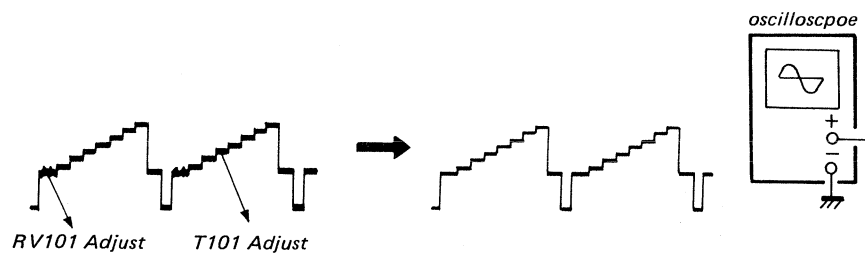

3.58 (APC-1) Adjustment

- (1) Receive NTSC color bars.
- (2) Ground the slider of RV106, thereby turning the color killer circuit off.
- (3) Connect IC103 pin 6 via a 10 μ F /16V electrolytic capacitor to the ground, thereby desynchronizing Color Sync.
- (4) Adjust Color Sync with RV104.

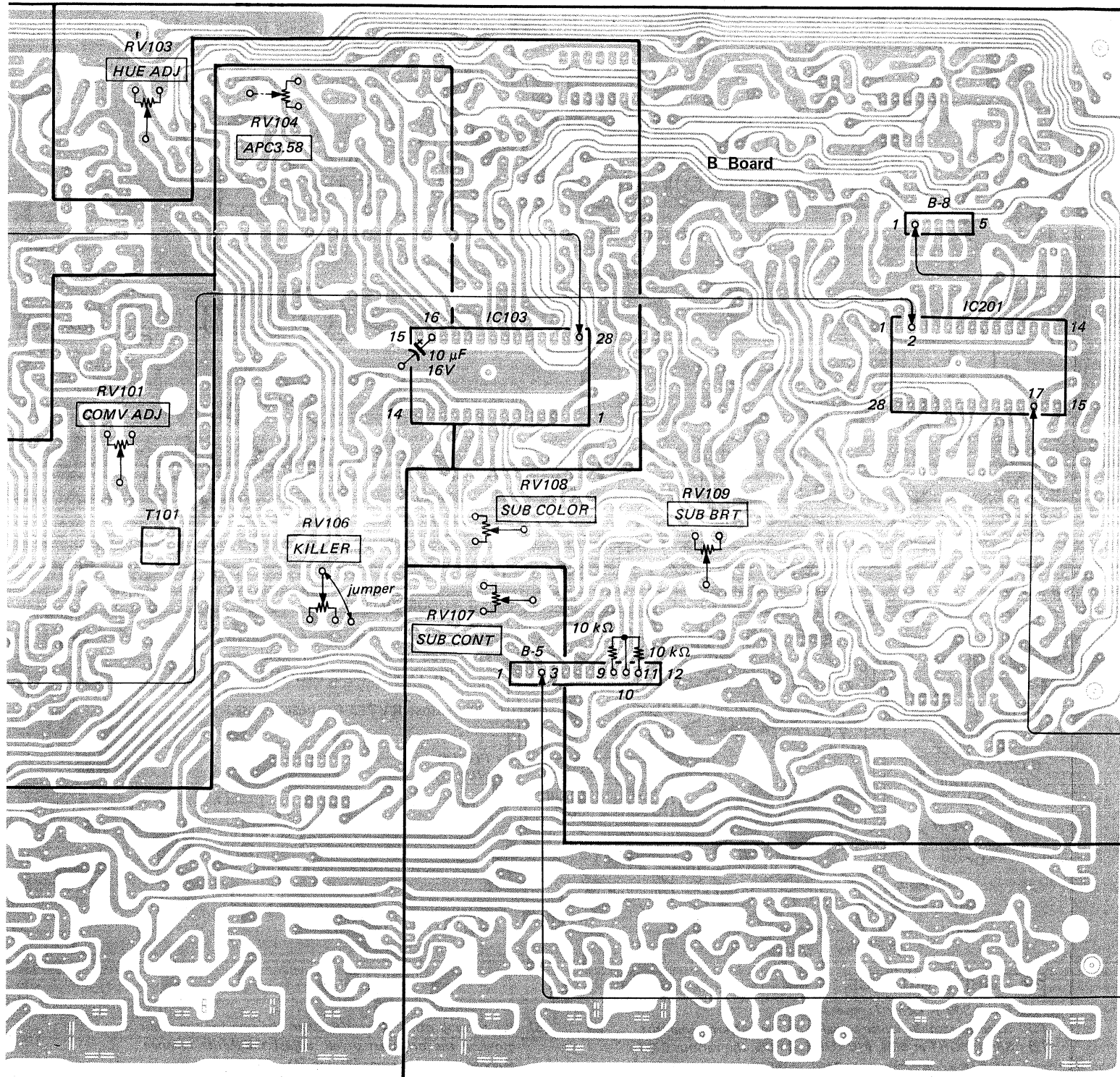

SUB BRIGHT Adjustment

- (1) Receive a monoscope signal.
- (2) Set BRIGHT and PICTURE for minimum position.
- (3) Observe B8 connector pin ① (B out) on the oscilloscope, and adjust RV109 (sub-bright) so that the pedestal level is 2.8V DC.

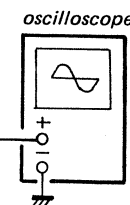

Sub-Color Adjustment

- (1) Receive color bars.
- (2) Adjust RV108 and RV103 for the waveform at connector B-8 ① (B Out) to be made as illustrated.

Hue Adjustment

- (1) Connect resistors to connector B5 as illustrated to the left.
- (2) Receive color bars.
- (3) Adjust the waveform at IC201 pin ⑰ (B-Y) as illustrated with RV103.

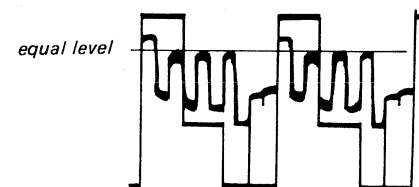
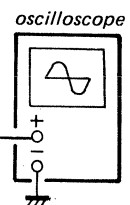

SUB CONTRAST Adjustment

- (1) Receive a monoscope signal.
- (2) Set PICTURE control to maximum.
- (3) Observe the B-5 connector pin ③ (B out) on the oscilloscope, and adjust the subcontrast VR (RV107) so that the signal element is 2.5V.

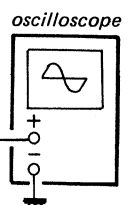

4-2. D BOARD ADJUSTMENTS

4-3. SAFETY RELATED ADJUSTMENTS

Horizontal Oscillator Frequency Adjustment

- (1) Receive a monoscope signal.
- (2) Set PIC VR at 80% and BRT VR at 50%, and connect for an external sync.
- (3) Ground the Q502 base.
- (4) Turn H FREQ VR (RV504), and adjust for the image to stop flowing.

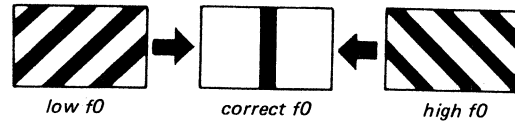

Horizontal Deflection Block Adjustment

- (1) Receive a monoscope signal.
- (2) Set BRIGHT at 80% and BRIGT at 50%.
- (3) Turn H PHASE VR (RV505), verify that the H center will shift accordingly, and turn the VR to the extreme clockwise position.
- (4) Turn H CENT VR (RV506), and verify that the H center will shift accordingly.
- (5) Turn the HLC (L505) core for the picture size to be maximized.
- (6) Adjust H SIZE VR (RV801) for the H size at screen center to be made 16 frames.

PIN PHASE ADJUSTMENT

Adjust RV802 to make vertical lines straight as shown.

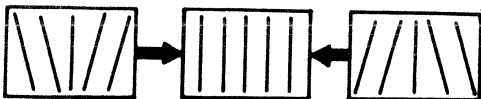

PIN AMP ADJUSTMENT

Adjust RV803 to make vertical lines straight as shown.

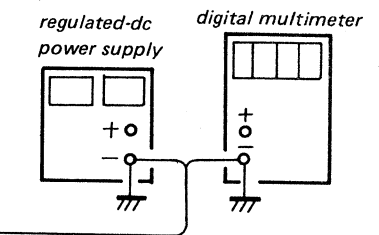
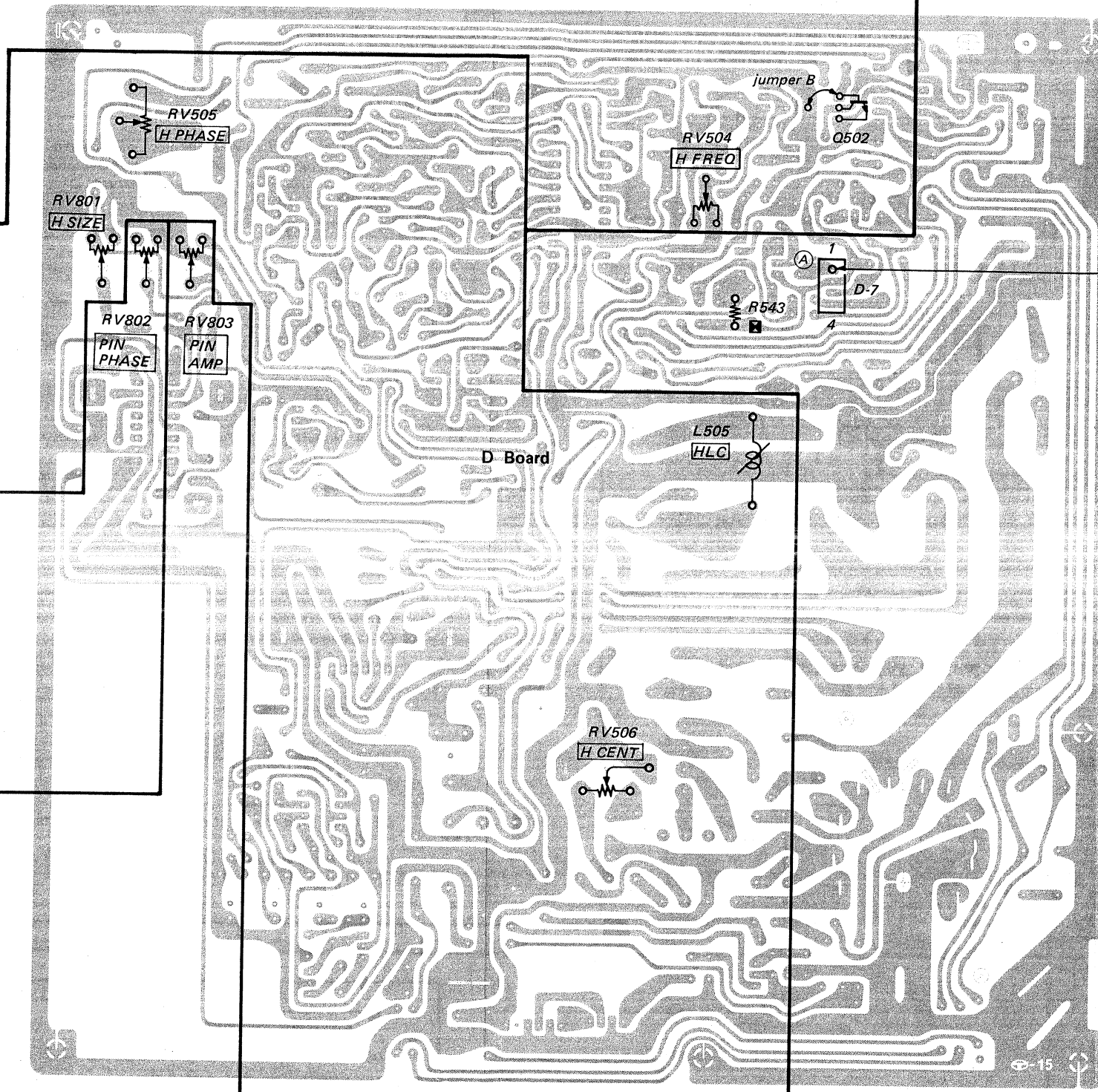
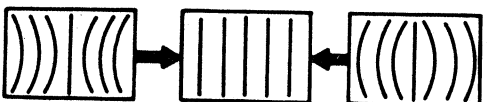

Hold Down Adjustment (R543 Adjustment)

Be sure to perform this after replacing the parts below (marked \blacksquare on the schematic).

D507, D508, D523, IC503, Q511, R540, R541, R542, R543, R544, R545, R590, R591, R592, R593

Note: The ① pin of D-7 connector is the hold down check point (A).

1. Feed in color-bar signal.
2. Set the BRIGHT, PICTURE & COLOR control to minimum.
3. Confirm that the HV HOLD DOWN CIRCUIT operates and the raster disappears when 18.50V DC is applied to hold down check point (A) from an external DC power supply.
Note: When raster disappears, cut input voltage and applied voltage immediately.
4. Confirm that the HV HOLD DOWN CIRCUIT does not operate when 17.65V DC is applied to hold down check point (A) from an external DC power supply.
Note: If the HV HOLD DOWN CIRCUIT operates, immediately cut input and applied voltage.
5. Feed in an all-white signal.
6. Confirm that the HV HOLD DOWN CIRCUIT operates and the raster disappears when 17.40V DC is applied to hold down check point (A) from an external DC power supply.
Note: When raster disappears, cut input voltage and applied voltage immediately.
7. Confirm that the HV HOLD DOWN CIRCUIT does not operate when 16.30V DC is applied to hold down check point (A) from an external DC power supply.
Note: If the HV HOLD DOWN CIRCUIT operates, immediately cut input and applied voltage.
8. Adjust R543 so that steps 3, 4, 6 and 7 are satisfied.

4-3. SAFETY RELATED ADJUSTMENTS

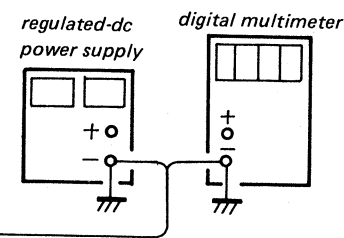

Hold Down Adjustment (R543 Adjustment)

Be sure to perform this after replacing the parts below (marked \blacksquare on the schematic).

D507, D508, D523, IC503, Q511, R540, R541, R542, R543, R544, R545, R590, R591, R592, R593

Note: The ① pin of D-7 connector is the hold down check point (A).

1. Feed in color-bar signal.
2. Set the BRIGHT, PICTURE & COLOR control to minimum.
3. Confirm that the HV HOLD DOWN CIRCUIT operates and the raster disappears when 18.50V DC is applied to hold down check point (A) from an external DC power supply.

Note: When raster disappears, cut input voltage and applied voltage immediately.

4. Confirm that the HV HOLD DOWN CIRCUIT does not operate when 17.65V DC is applied to hold down check point (A) from an external DC power supply.

Note: If the HV HOLD DOWN CIRCUIT operates, immediately cut input and applied voltage.

5. Feed in an all-white signal.
6. Confirm that the HV HOLD DOWN CIRCUIT operates and the raster disappears when 17.40V DC is applied to hold down check point (A) from an external DC power supply.

Note: When raster disappears, cut input voltage and applied voltage immediately.

7. Confirm that the HV HOLD DOWN CIRCUIT does not operate when 16.30V DC is applied to hold down check point (A) from an external DC power supply.

Note: If the HV HOLD DOWN CIRCUIT operates, immediately cut input and applied voltage.

8. Adjust R543 so that steps 3, 4, 6 and 7 are satisfied.

+B Adjustment (R669 Adjustment)

Be sure to perform this after replacing the parts below (marked \blacksquare on the schematic).

C654, IC651, R652, R660, R661, R669

1. Supply 120V AC with variable auto-transformer.
2. Adjust the resistance value of R669 so that +B voltage is 115.0V \pm 1.0V DC.

MAXIMUM +B VOLTAGE Adjustment (R668 Adjustment)

Be sure to perform this after replacing the parts below (marked \blacksquare on the schematic).

D654, IC651, Q652, Q653, R658, R659, R666, R667, R668

1. Connect pin ① of IC651 to the ground with a jumper wire.
2. Supply 130 \pm 2 V AC to with variable auto-trans-within the former.
3. Tune in an off air signal.
4. Adjust the resistance value of R668 so that +B voltage is within the range of 115,0 \pm 1.0 V DC.

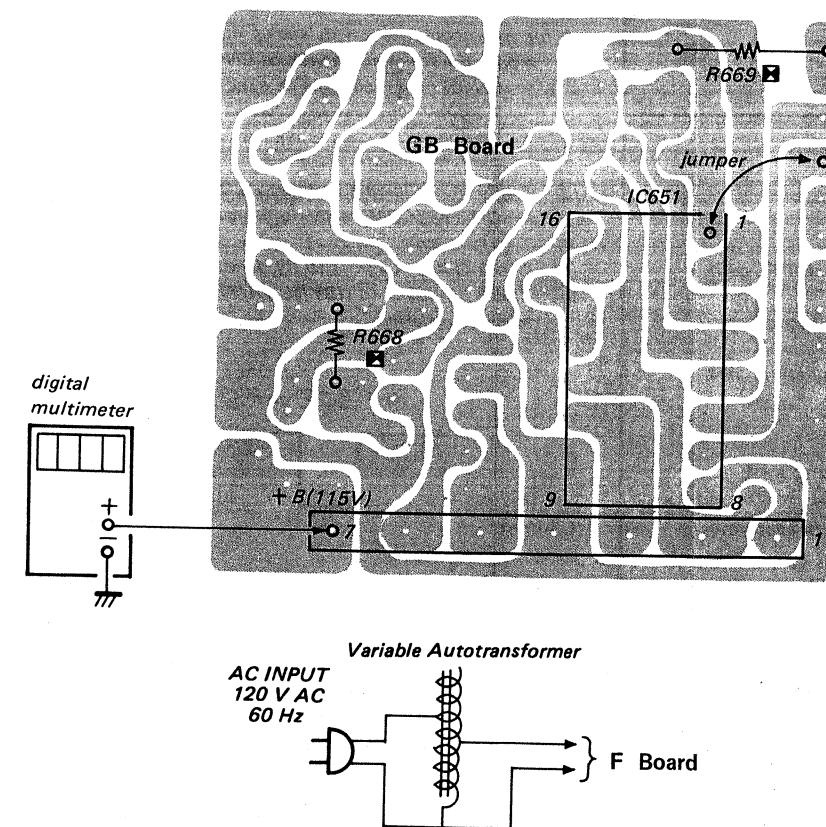

+B Adjustment (R669 Adjustment)

Be sure to perform this after replacing the parts below (marked \blacksquare on the schematic).

C654, IC651, R652, R660, R661, R669

1. Supply 120V AC with variable auto-transformer.
2. Adjust the resistance value of R669 so that +B voltage is $+1.0V$ to $-2.0V$ DC.

MAXIMUM +B VOLTAGE Adjustment (R668 Adjustment)

Be sure to perform this after replacing the parts below (marked \blacksquare on the schematic).

D654, IC651, Q652, Q653, R658, R659, R666, R667, R668

1. Connect pin ① of IC651 to the ground with a jumper wire.
2. Supply 130^{+2}_{-0} V AC to with variable auto-trans-within the former.
3. Tune in an off air signal.
4. Adjust the resistance value of R668 so that +B voltage is within the range of $115.0^{+1.0}_{-2.0}$ V DC.

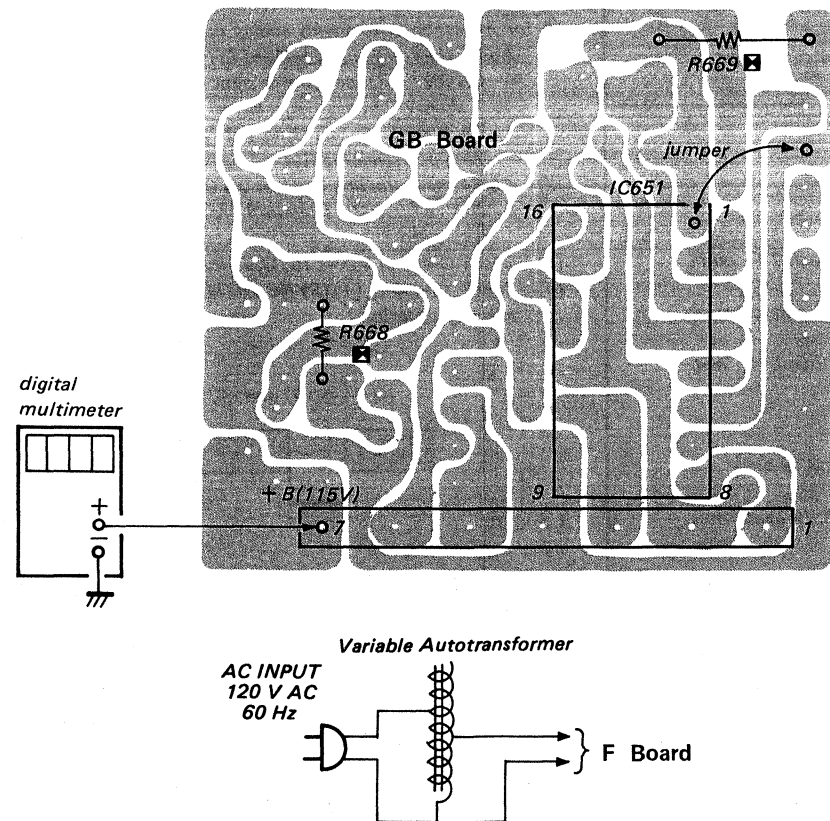

4-4. Q BOARD ADJUSTMENTS

Superimpose Operation Check

- (1) Signal input setting is the same as for Overall Check (1)-(3) on page 28.
- (2) Input selection: CMPTR (Q-7 ⑤) ground level, ② ③ ④: open)
- (3) VIDEO SELECT
With CN407 ⑩ at ground level, check that Q-4 ② ③ ④ (BGR) are LINE A signals.
(Video select: LINE A)
- (4) AUDIO SELECT
1) CN407 ② ground level, AUDIO SELECT: LINE A.
2) Check that Q-2 ④ (AUDIO) becomes LINE A signal.
- (5) SYNC SELECT
1) CN407 ⑭: ground level, (Sync select: LINE A)
2) Check that Q-1 ① (SYNC OUT) becomes LINE A signal.
(INT SYNC mode: LINE A composite video, EXT SYNC mode: external sync signal are output.)
- (6) Superimpose Operation
Apply a BLK signal to CN407 ⑫ and check that the CMPTR picture is superimposed on the LINE A picture.
(CN407 ⑩, ②, ④ (VIDEO, AUDIO, SYNC SELECT) are open, CMPTR is selected.)

COMPTR (3 Bit TTL) Check

- (* for normal 8 color display microcomputers)
- (1) Apply the following signals to CN407.
 - 1) CN407 ④: B, ⑤: G, ⑥: R (R, G, B each TTL compatible positive polarity)
 - 2) CN407 ③: horizontal sync signal, ⑪: vertical sync signal
(Both horizontal and vertical TTL compatible neg. polarity)
 - ⑮ ground level (I not used)
 - ⑨ ground level (LEV-SEC TTL)
 - ① ground level (*IBM-ID other than IBM (3 bit))
 - (2) Q-7 ⑤ ground level (*Select COMPTR)
 - (3) Check Q-4 ②, ③, ④, (B, G, R) output. (Waveform is the same as 4 CMPTR analog.)

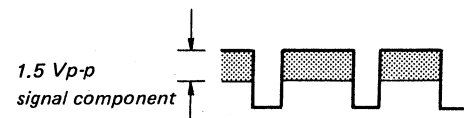

- (4) Check that Q-5 ① SYNC OUT is about 2 Vp-p negative polarity.

Power Supply Operation Check

- (1) Connect the Q-3 connector and apply the following voltages.
Q-3 connector
(1) +8V
(2) +15V
(3) common ground
- (2) Check the voltage at the following points.
F401: ⑧ 5 ± 0.25
CN407 ⑧: 5 ± 0.25
F403 ⑫: ± 0.6
CN407 ⑦: 12 ± 0.6
Q4 ①: 12 ± 0.6

digital multimeter

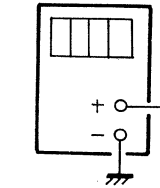

COMPTR (ANALOG) Check

- (* for microcomputers with analog output such as SMC-70)
- (1) Apply the following signals to CN407.
 - CN407 ③: composite sync signal (COMP SYNC) 1 Vp-p/75Ω negative polarity)
 - CN407 ④: B, ⑤: G, ⑥: R (R, G, B each 0.7 Vp-p/75Ω positive polarity)
 - (2) Apply the following voltages via Q-7 connector.
 - Q-7 ⑤ (COMP selection): ground, Q-7 ②, ③, ④, ⑥; open
 - (3) Check Q-4 ②, ③, ④, (B, G, R) outputs as shown below.
 - (4) Check that Q-5 ① (SYNC OUT) level is about 2 Vp-p negative polarity.

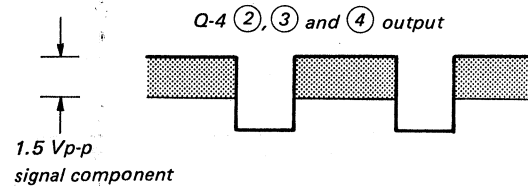

oscilloscope

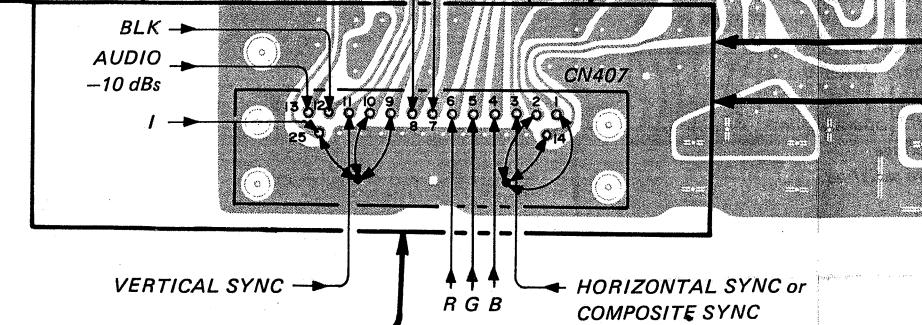
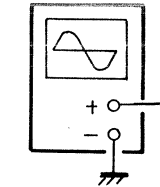

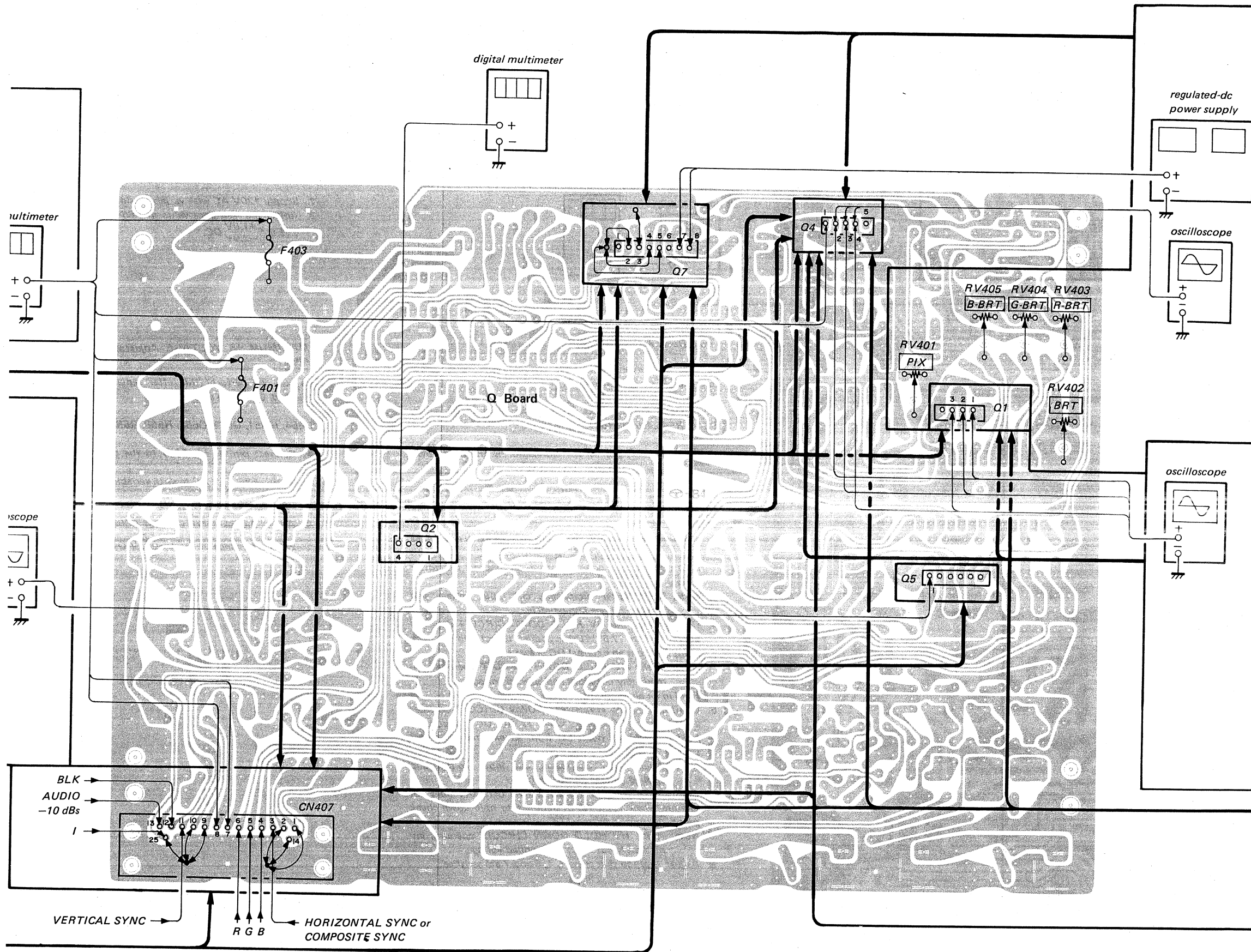

R, G, B System Operation Check and Preset

- PICTURE: minimum
 BRIGHT: Set at mechanical center
- Apply the following voltages via the Q-7 connector.
 - Q-7 (4) (RGB selection): ground level
 - Q-7 (7) (PIC): 4.0V DC
 - Q-7 (8) (BRT): 6.0V DC

- Connector input
 Apply RGB signal to each of the following inputs:
 CN401: R
 CN403: G
 CN405: B
- BRT Adjustment
 - Set G-BRT (RV404) at mechanical center.
 - Adjust BRT (RV402) so that Q-4 connector (3) (G output) pedestal level is 2.8V DC.



- Adjust B-BRT (RV405) in the same way for Q-4 connector (2) (B output).
- Adjust R-BRT (RV403) in the same way for Q-4 connector (4) (R output).
- PIC Adjustment
 PICTURE: maximum
 - Q-7 connector (7) (PIC): 12.0V DC
 - Adjust PIC (RV401) so that Q-4 connector (3) (G output) signal component is 2.5 Vp-p.
 - Check that Q-4 connector (2) (B output) and (4) (R output) are also 2.5 Vp-p.

COMPOSITE System Operation Check

- BRIGHT: mechanical center
 PICTURE: center
- Apply the signal shown to Q-1 connector. (This level corresponds to the B.8 output when 1 Vp-p composite input is applied to the B board.)

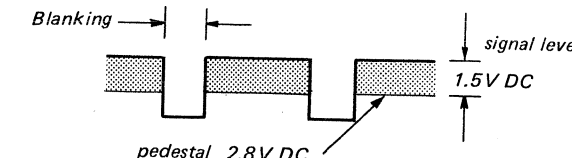

- Check that the input waveforms are equal at the following points.
 - B:Q-1 connector (1) Q4 connector (2)
 - G:Q-1 connector (2) Q4 connector (3)
 - R:Q-1 connector (3) Q4 connector (4)

CMPTR (IBM) Check

- (*IBM 5150 personal computer)
- Apply the following signals to CN407.
 - CN407 (25): I (4) B (5) G (6) R
 - All TTL compatible positive polarity
 - (3): H SYNC (7): V SYNC
 - TTL compatible positive polarity
 - CN407 (9): ground level (LEV-SEC TTL)
 - Q-7 (5): ground level (CMPTR select)
 - Check Q-4 (2), (3), (4) (B, G, R) outputs. (Waveform is the same as 4 CMPTR analog.)

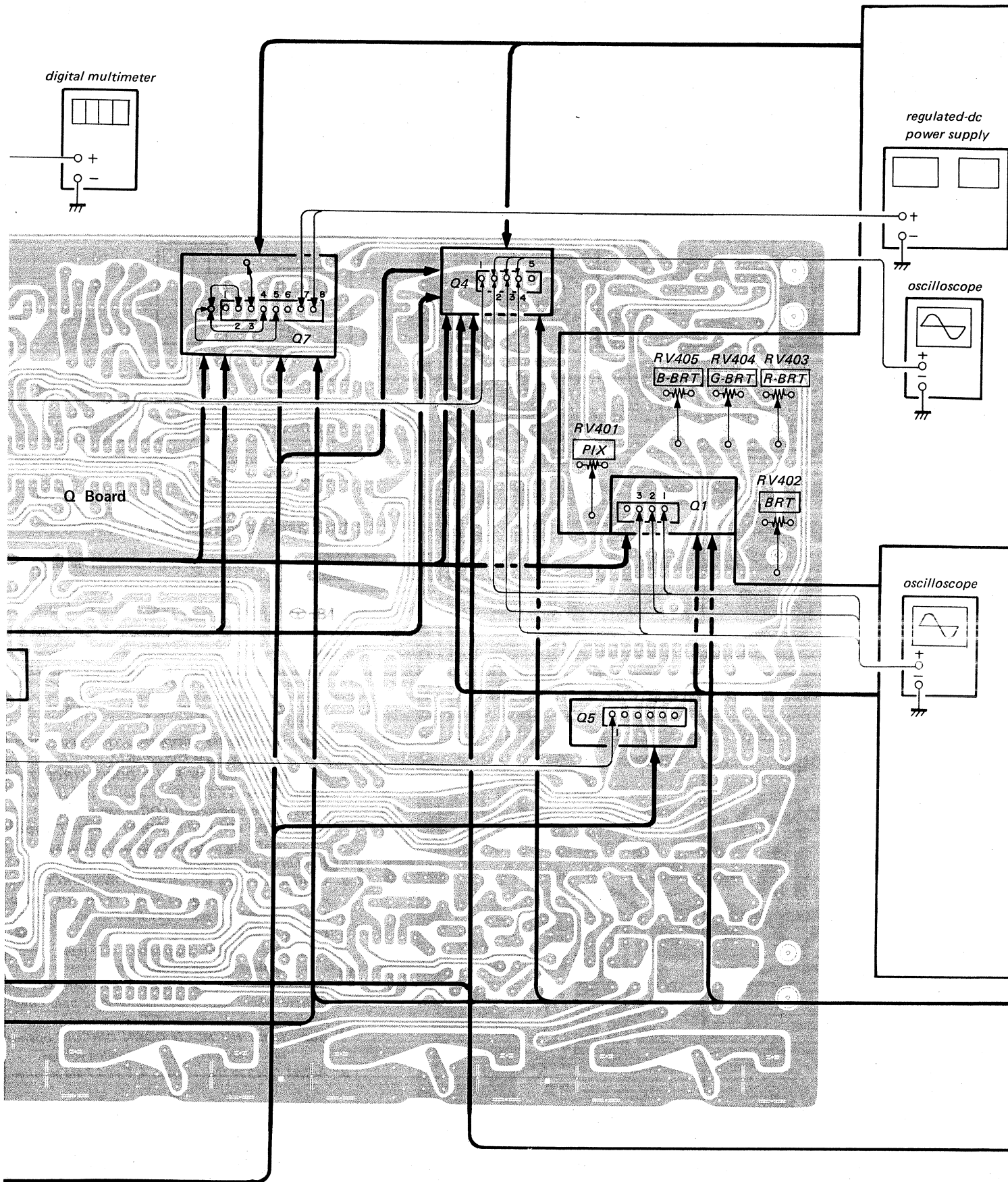

R, G, B System Operation Check and Preset

- PICTURE: minimum
BRIGHT: Set at mechanical center
- Apply the following voltages via the Q-7 connector.
 - Q-7 (4) (RGB selection): ground level
 - Q-7 (7) (PIC): 4.0V DC
 - Q-7 (8) (BRT): 6.0V DC
 - Connector input
Apply RGB signal to each of the following inputs:
CN401: R
CN403: G
CN405: B
 - BRT Adjustment
 - Set G-BRT (RV404) at mechanical center.
 - Adjust BRT (RV402) so that Q-4 connector (3) (G output) pedestal level is 2.8V DC.

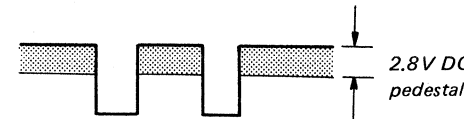

- Adjust B-BRT (RV405) in the same way for Q-4 connector (2) (B output).
- Adjust R-BRT (RV403) in the same way for Q-4 connector (4) (R output)
- PIC Adjustment
PICTURE: maximum
 - Q-7 connector (7) (PIC): 12.0V DC
 - Adjust PIC (RV401) so that Q-4 connector (3) (G output) signal component is 2.5 Vp-p.
 - Check that Q-4 connector (2) (B output) and (4) (R output) are also 2.5 Vp-p.

COMPOSITE System Operation Check

- BRIGHT: mechanical center
PICTURE: center
- Apply the signal shown to Q-1 connector. (This level corresponds to the B.8 output when 1 Vp-p composite input is applied to the B board.)

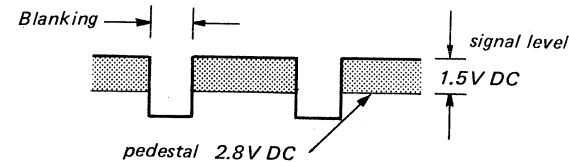

- Check that the input waveforms are equal at the following points.
 - B: Q-1 connector (1) Q4 connector (2)
 - G: Q-1 connector (2) Q4 connector (3)
 - R: Q-1 connector (3) Q4 connector (4)

COMPTR (IBM) Check

- (*IBM 5150 personal computer)
- Apply the following signals to CN407.
 - CN407 (25): 1 (4) B (5) G (6) R
 - All TTL compatible positive polarity
 - (3): H SYNC (17): V SYNC
 - TTL compatible positive polarity
 - CN407 (9): ground level (LEV-SEC TTL)
 - Q-7 (5): ground level (COMPTR select)
 - Check Q-4 (2), (3), (4) (B, G, R) outputs. (Waveform is the same as 4 COMPTR analog.)

Overall Operation Check

- Connect Q1, Q2, Q3, Q4, Q5 and Q7, and B, D and H boards.
- Apply video and audio signals to B board A, B VTR inputs. Also, apply a composite sync signal to the external sync input. (video input (composite) 1 Vp-p/75Ω audio input -10 dB external sync input 4 Vp-p/75Ω negative polarity)
- Q Board
 - Apply these signals to R, G, B video and audio inputs. (video input (component RGB) 0.7 Vp-p/75Ω audio input -10 dBs)
 - Apply input signals to CMPTR connector.
 - CN407 (3) composite sync signal 1 Vp-p/75Ω (4), (5), (6), B, G, R -0.7 Vp-p/75Ω
 - CN407 (13) AUDIO -10 dBs
- LINE A Check
 - Input selection is LINE A, and sync selection is INT SYNC. (Q-7 (2), (3), (4), (5), (7) open)
 - Check that LINE A decoded RGB signal is being output at Q-4 (2), (3), (4), B, G, R.
 - Check that Q-2 (4) AUDIO is LINE A. (Level drops about -16 dBs (about 6 dB from connector input.))
 - Check that there is LINE A video at Q-1 (1) (SYNC OUT) (Level is 2 Vp-p)
 - Change sync selection to EXT SYNC. Check that at this time Q-1 (1) changes to composite sync signal from external sync connector. (Q-7 (6) is ground level, output level about 2 Vp-p, negative polarity)
- LINE B Check Select LINE B. (Q-7 (2) ground level (3), (4), (5) open) Repeat steps 2)-5) for LINE A.
- VTR Check Select VTR. (Q-7 (3) ground level (2), (4), (5) open) Repeat steps 2)-5) for LINE A.
- RGB Check
 - Make input selection RGB. Svc selection is internal sync. (Q-7 (4) ground level, (2), (3), (6) open)
 - Check that signals from R, G, B are coming out on Q-4 (2), (3), (4) (R, G, B).
 - Q-2 (4) (AUDIO) signal should be from RGB.
 - Check that there is a composite sync signal from external sync connector at Q-1 (1) (SYNC OUT).
 - Make sync selection EXT SYNC and make sure that Q-1 (1) output does not change. (In RGB mode, external sync is selected regardless of INT/EXT.)
- COMPTR Check
 - Input selection: COMPTR, Sync selection: INT SYNC (Q-7 (5) ground level (2), (3), (4) open)
 - Check Q-4 (2), (3), (4) (B, G, R) and check Q-2 (4) (AUDIO).
 - Check that Q-1 (1) (SYNC OUT) is the signal from CN407 (3).
 - Check that Q-1 (1) does not change when changing sync selection from INT/EXT.

- Check that Q-5 (1) (SYNC OUT) is about 2 Vp-p negative polarity.

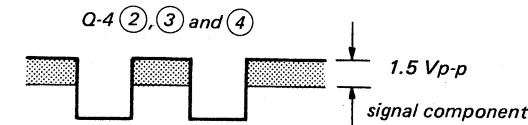

SECTION 5
DIAGRAMS

5-1. CIRCUIT BOARDS LOCATION

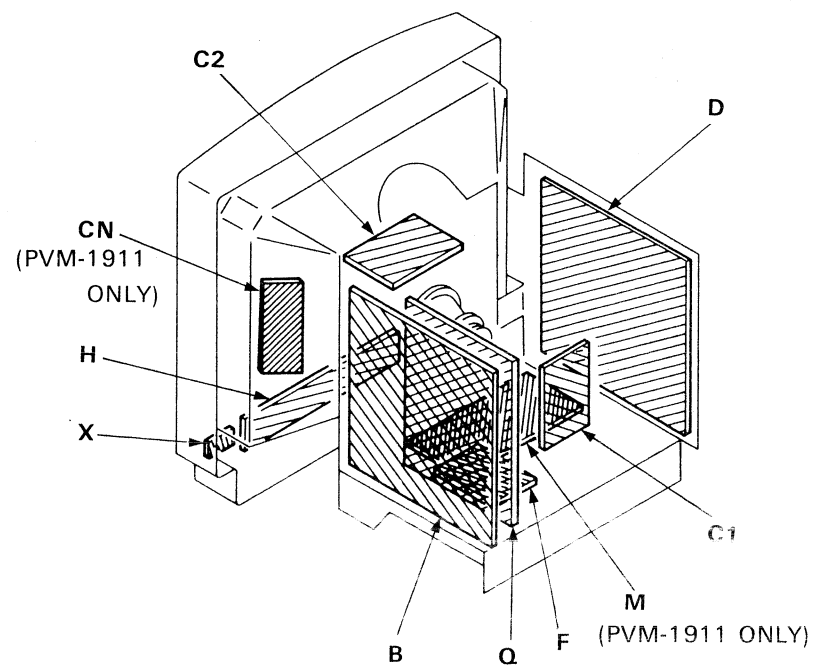

5-2. BLOCK DIAGRAM

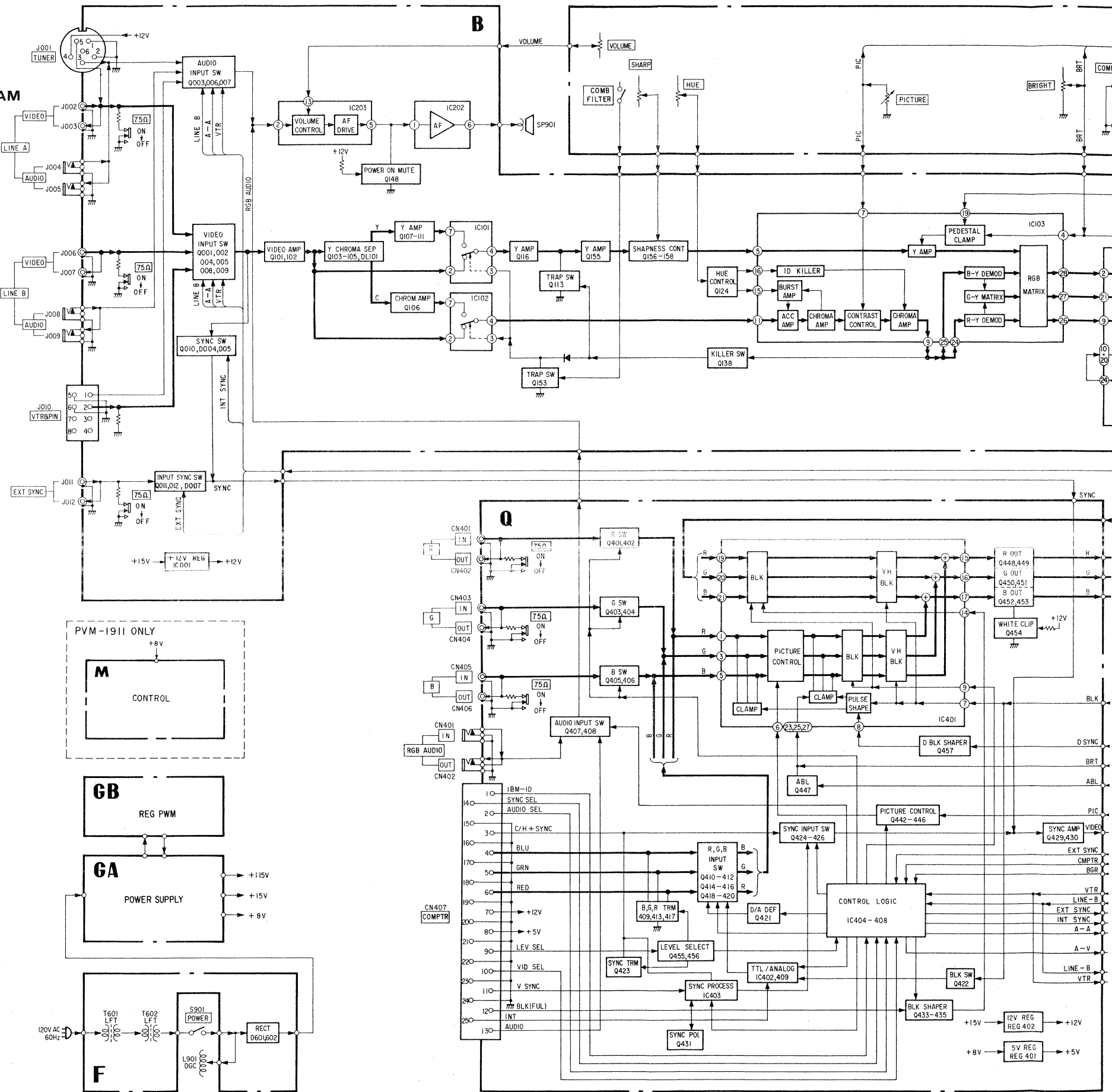

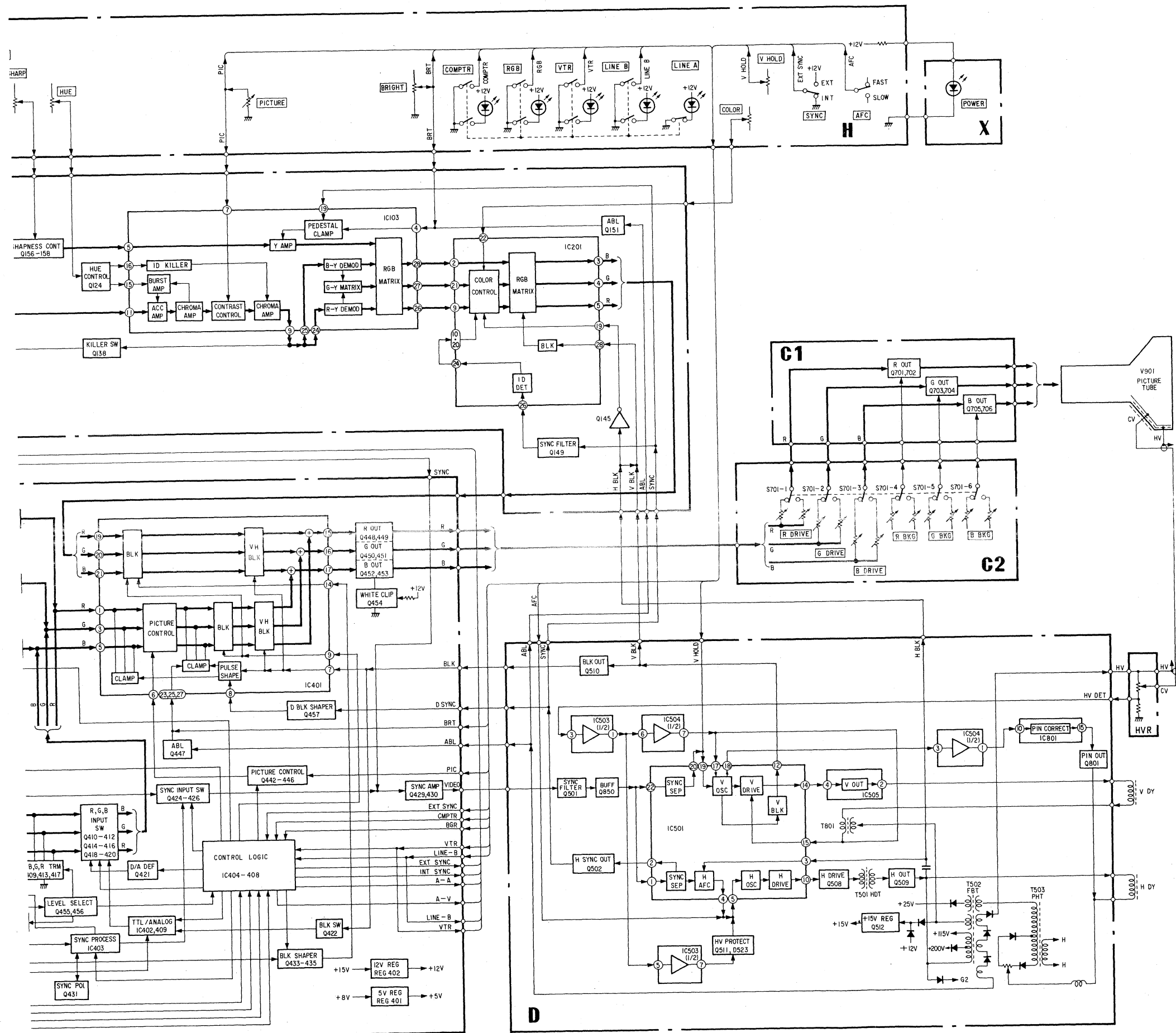

5-3. SEMICONDUCTORS

μPC1241H

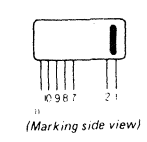

μPC1364C2
μPC1365C
CX22019

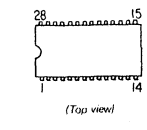

μPC1377C

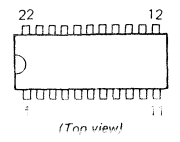

μPC1378H-L

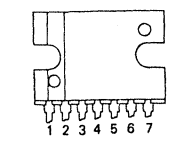

μPC4558C

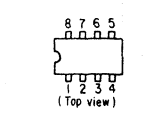

μPC7805H
μPC7812H
μPC7812H

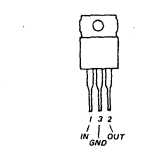

2SA1175
2SC2785

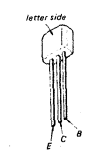

2SA733
2SA844
2SC1363
2SC1815
2SC945

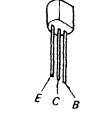

2SC2611
2SC2688

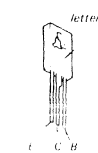

2SD1134

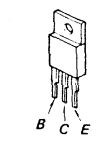

2SA1026

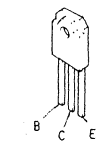

2SA1048
2SA1115
2SC2458
2SC2603
DTA124ES

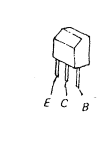

2SD774

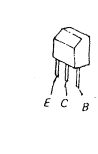

2SK



1SS1
1SS1
1SS1

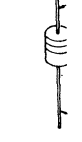

CR02

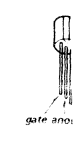

EQAC
GP08

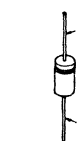

EQB0
RH1A
RH1Z
S1B01

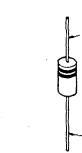

ERC2



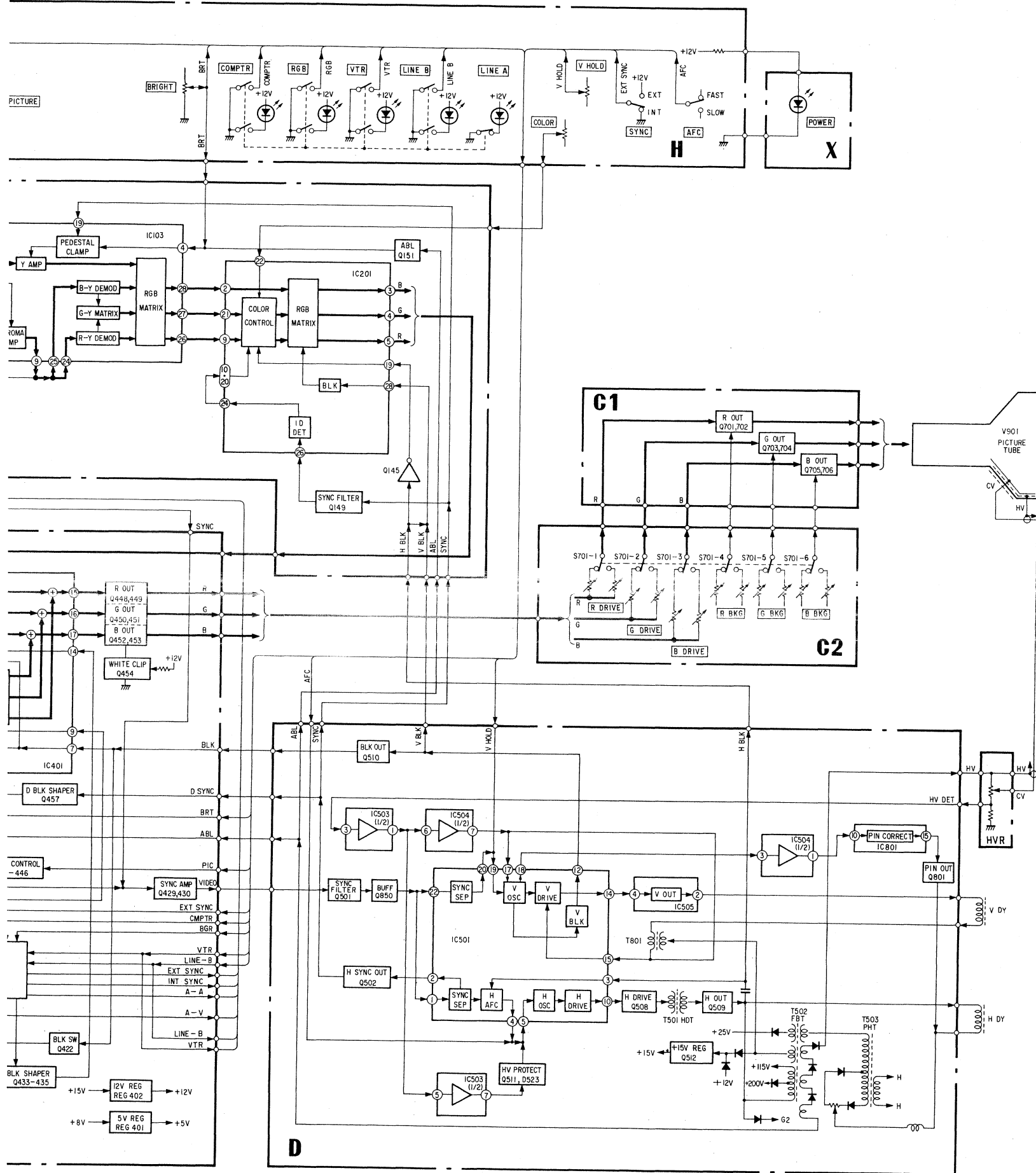

5-3. SEMICONDUCTORS

μPC1241H

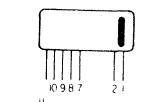

(Marking side view)

μPC1364C2
μPC1365C
CX22019

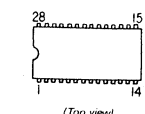

(Top view)

μPC1377C

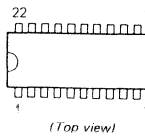

(Top view)

μPC1378H-L

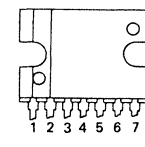

μPC4558C

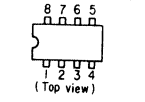

μPC7805H
μPC7812H
μPC78M12H

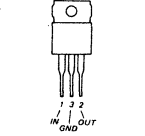

CX095E
SN74LS00N
SN74LS04N
SN74LS08N
SN74LS09N
SN74LS136N
SN74LS20N

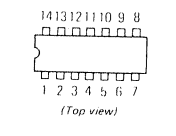

CX20061

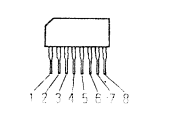

SN74LS138N
TDA1082

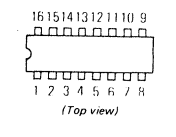

2SA1026

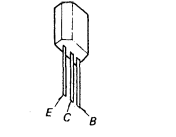

2SA1048
2SA1115
2SC2458
2SC2603
DTA124ES

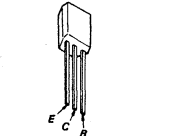

2SA1175
2SC2785

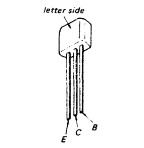

2SA733
2SA844
2SC1363
2SC1815
2SC945

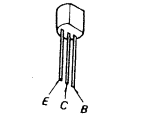

2SC2611
2SC2688

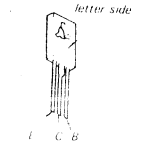

2SD1134

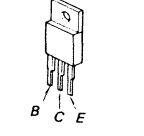

2SD1398

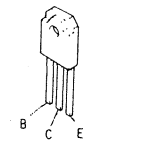

2SD774

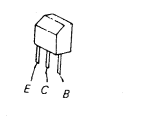

2SK107-3

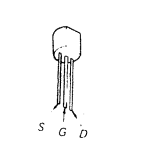

1SS119
1SS133
1SS148

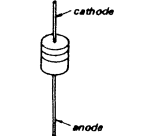

CRO2AM-4

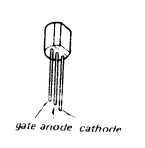

EQA01-19R
GP08D

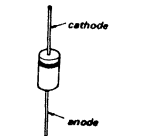

EQB01-22
RH1A
RH1Z
S1B01-02

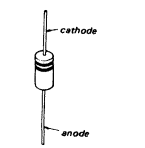

ERC26-15S

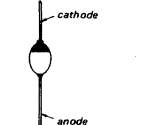

ERD28-08S
RD4.3E-B1
RD4.7E-B2
RD5.1E-N1
RD6.2E-B1
RD8.2E-N1
RD8.2E-N2

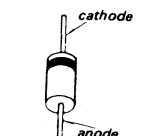

GH3F
U05G

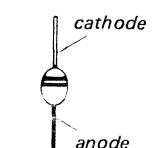

SG232D

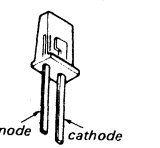

SY432D

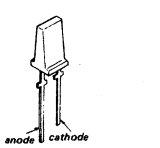

V19C
V19E
V30N

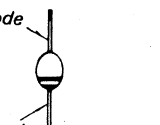

5-4. SCHEMATIC DIAGRAM

Note: The components identified by shading and mark **A** are critical for safety. Replace only with part number specified.

Note: Les composants identifiés par un tramé et une marque **A** sont critiques pour la sécurité. Ne les remplacer que par une pièce portant le numéro spécifié.

- All capacitors are in μF unless otherwise noted. pF : μF 50WV or less are not indicated except for electrolytics.
- All resistors are in ohms, 1/6W unless otherwise noted. $\text{k}\Omega = 1000\Omega$, $\text{M}\Omega = 1000\text{k}\Omega$
- Notice that the following boards have not a resistance wattage of 1/6W.
GA Board 1/4W (as a reference)
- : nonflammable resistor.
- : fusible resistor
- Δ : internal component.
- : panel designation.
- All variable and adjustable resistors have characteristic curve B, unless otherwise noted.
- The components identified by in this manual have been carefully factory-selected for each set in order to satisfy regulations regarding X-ray radiation. Should replacement be required, replace only with the value originally used.
- When replacing components identified by mark the necessary adjustments indicated. If results do not meet the specified value, change the component identified by and repeat the adjustment until the specified value is achieved. (Refer to R543, R668 & R669 adjustment on page 22.)
When replacing the part in below table, be sure to perform the related adjustment.

Part replaced ()	Adjustment ()
D507, D508, D523, IC503, Q511 R540, R541, R542, R543, R544 R545, R590, R591, R592, R593	R543
D654, IC651, Q652, Q653 R658, R659, R666, R667, R668	R668
C654, IC651, R652, R660, R661 R669	R669

- Readings are taken with a color-bar signal input to LINE A.
- Voltages are dc with respect to ground unless otherwise noted.
- The voltage of Q601 ~ Q603 is a reference value between emitter of Q601.
- Readings are taken with a 10M Ω digital multimeter.
- : adjustment for repair.
- Voltage variations may be noted due to normal production tolerances.
- : B + bus.
- ①: The number indicates No. of a waveform diagram.
For the waveform diagram, refer to pages 50 and 51.

*: Not measurable.

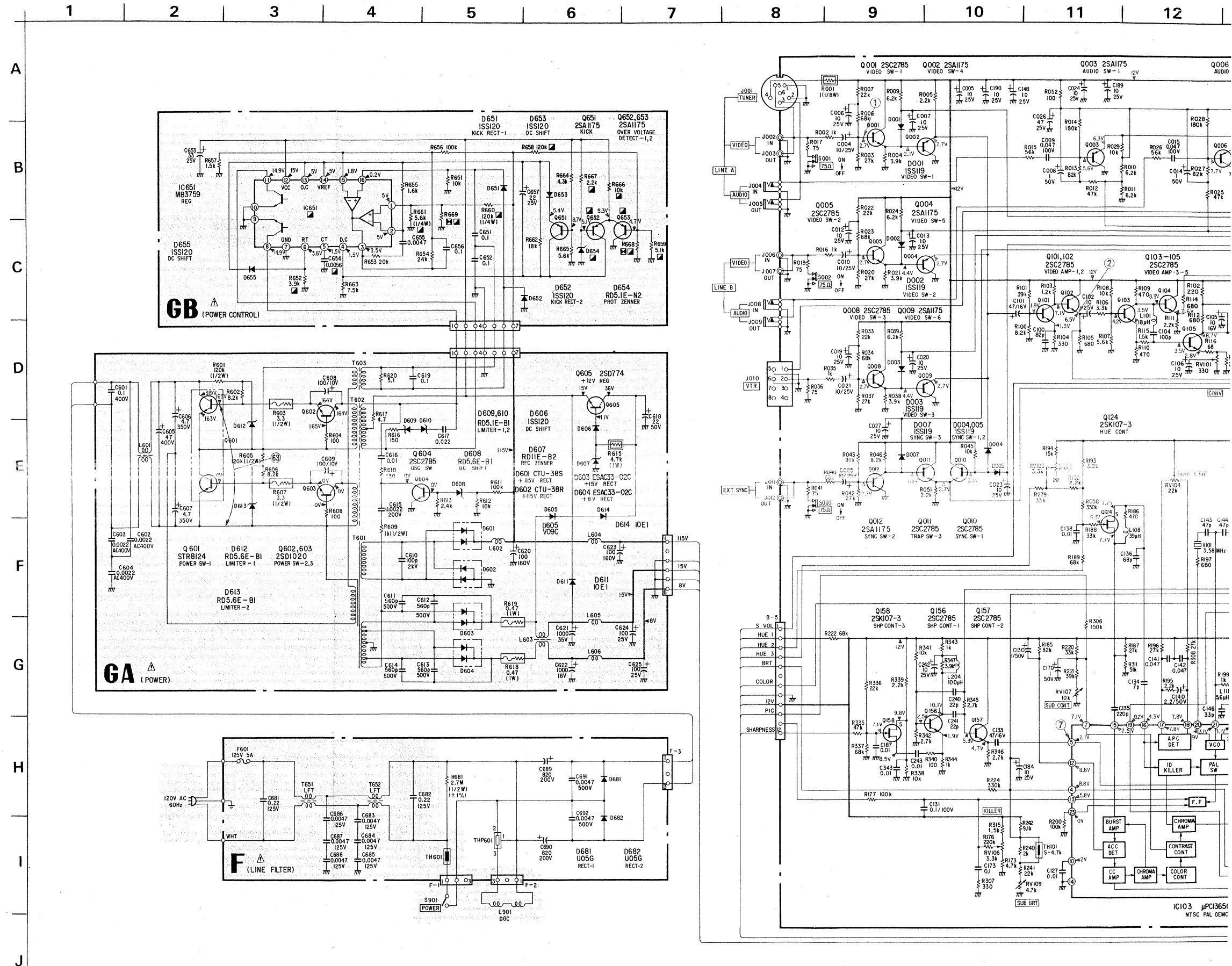

7 8 9 10 11 12 13 14 15 16 17 18 19 20 21 22

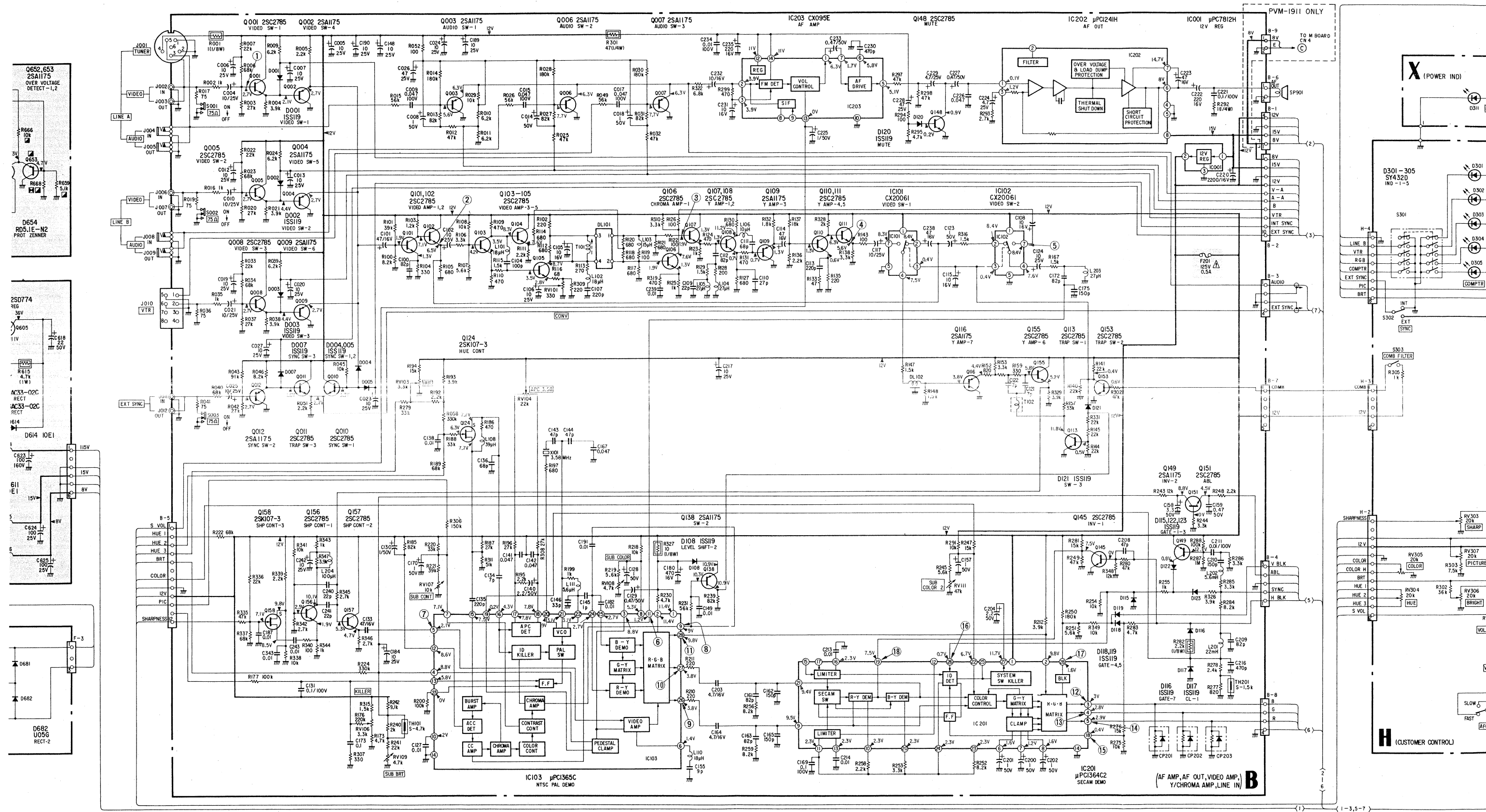

12 13 14 15 16 17 18 19 20 21 22 23 24 25 26 27

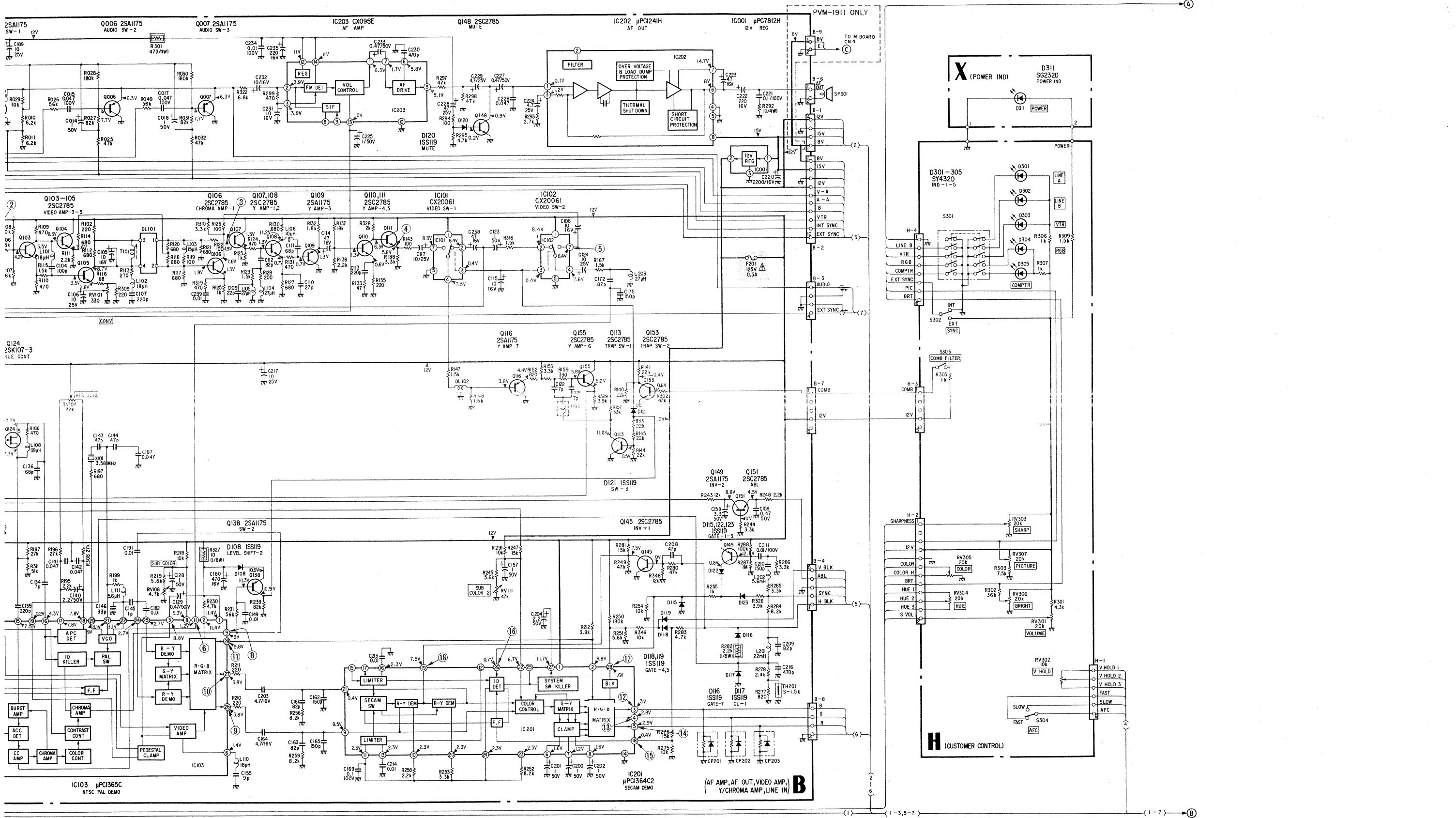

PVM-1910/1911 PVM-1910/1911

1 2 3 4 5 6 7 8 9 10 11 12 13 14 15 16

A
B
C
D
E
F
G
H
I

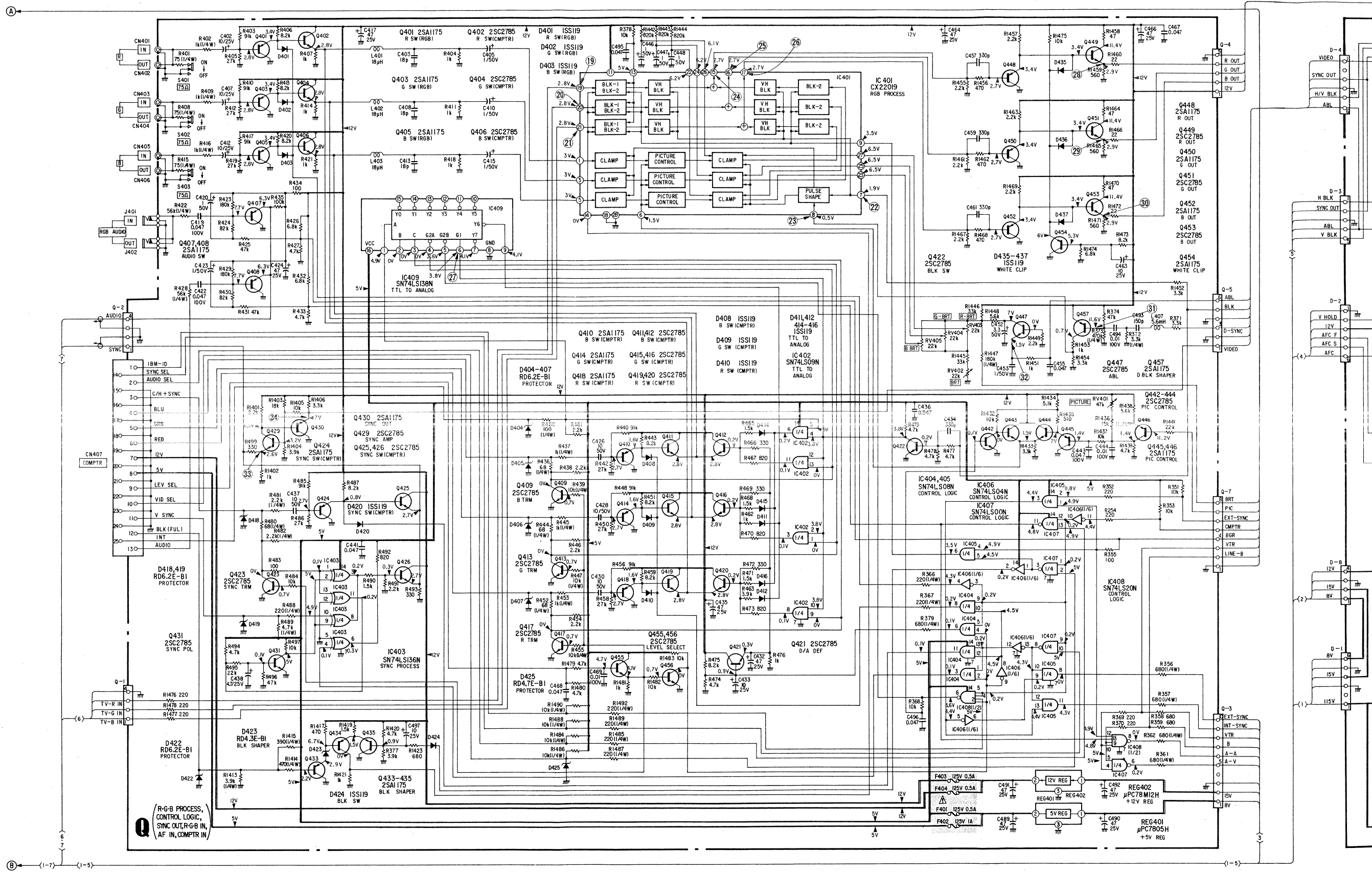

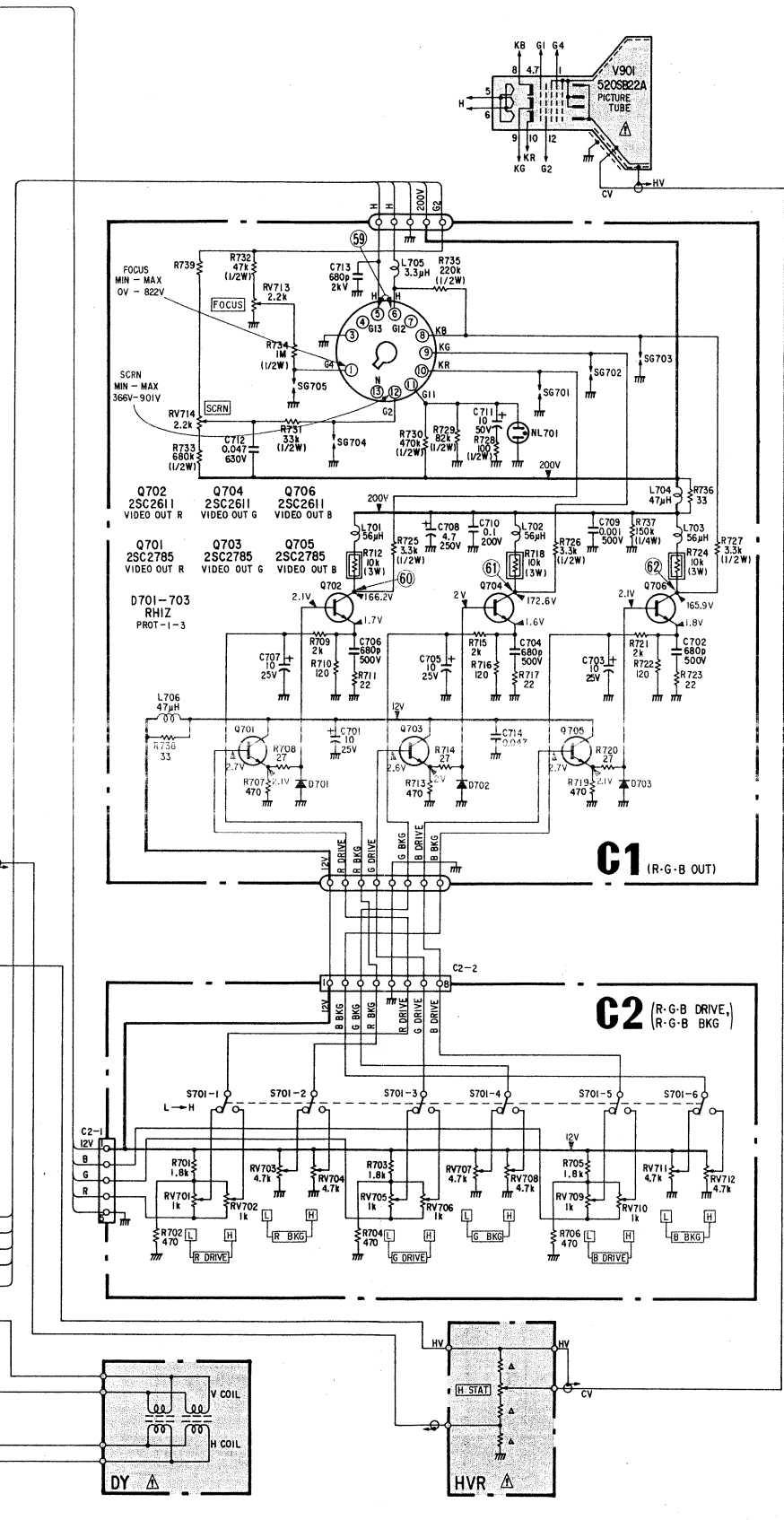
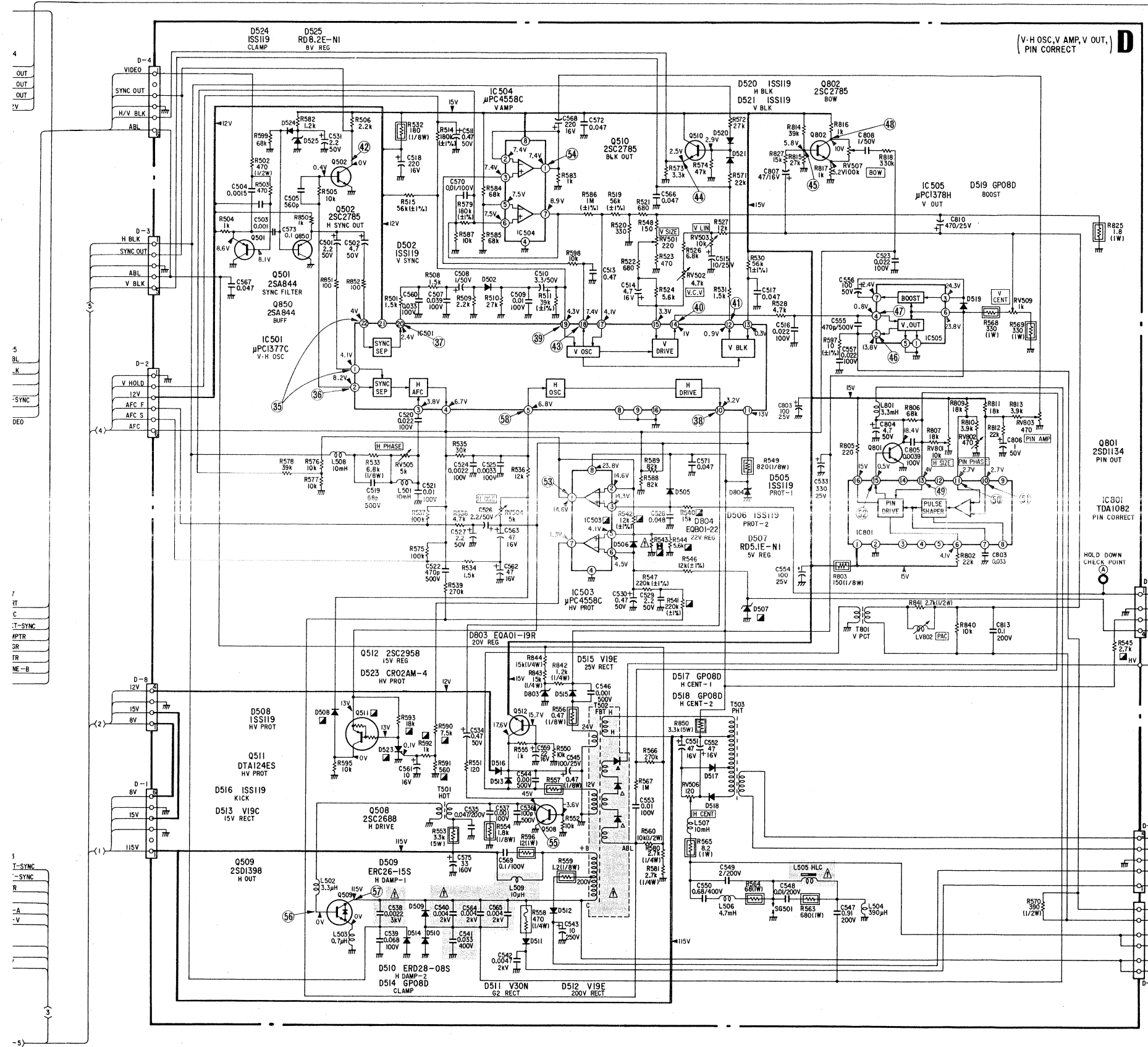

5-5. PRINTED WIRING BOARDS

GA (POWER)

GB (POWER CONTROL)

F (LINE FILTER)

X (POWER IND)

H (CUSTOMER CONTROL)

E

1 2 3 4 5 6 7 8 9 10 11 12 13 14 15 16

A
B
C
D
E
F
G
H
I

— GA Board —

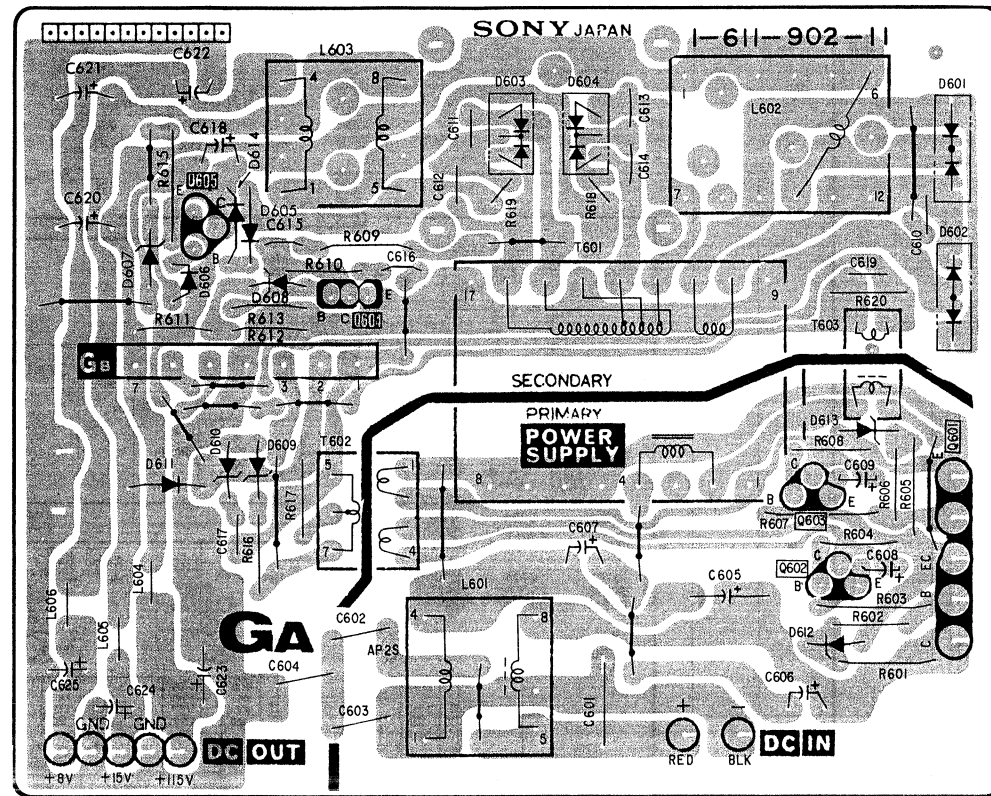

— GB Board —

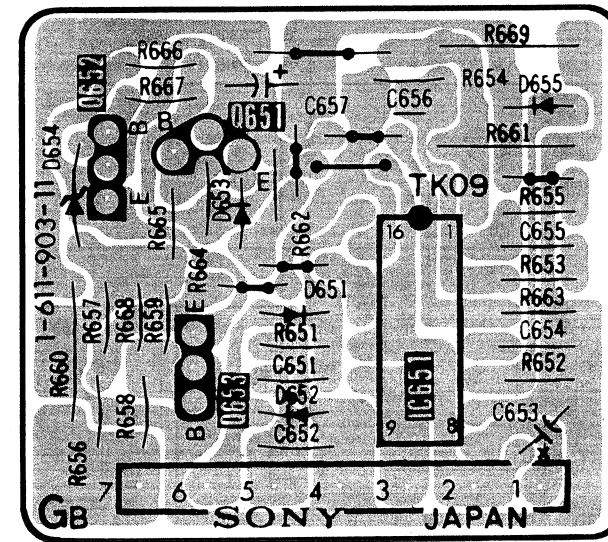

— X Board —

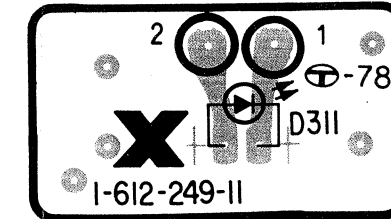

— B Board

— F Board —

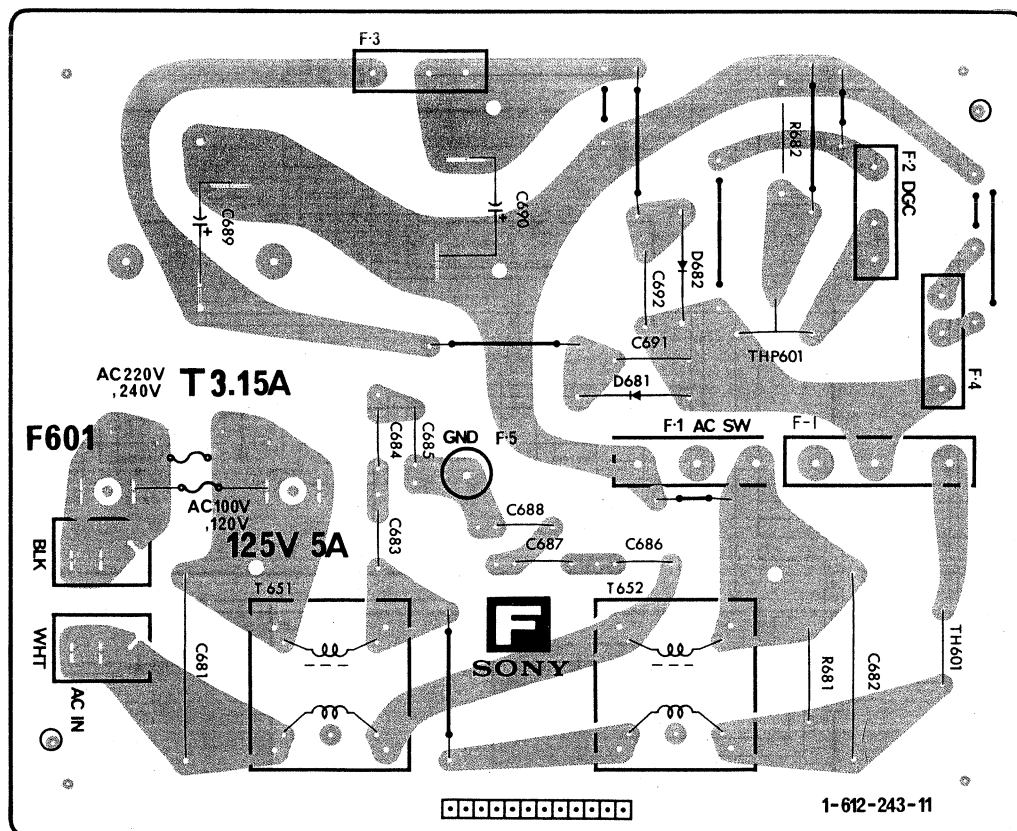

— H Board —

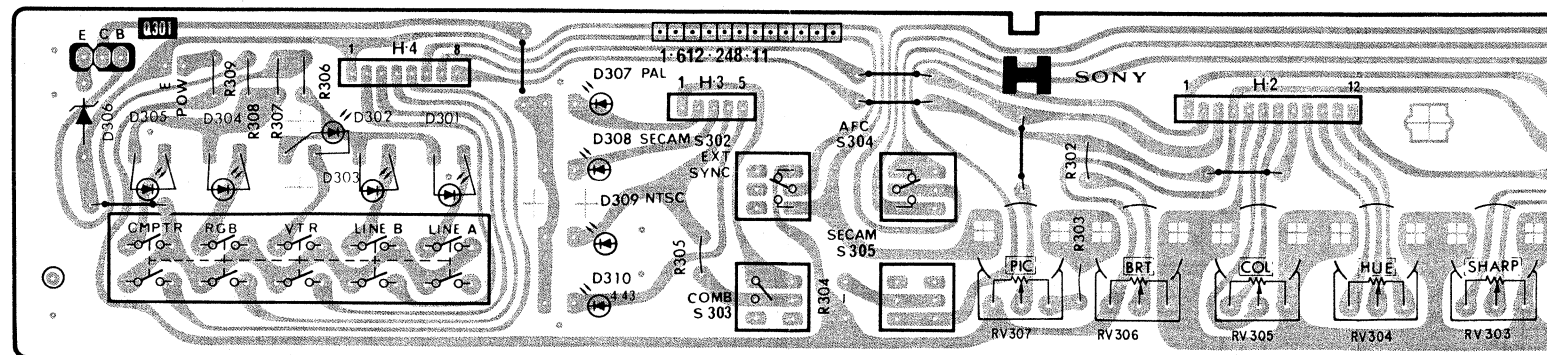

(CUSTOMER CONTROL)

B

(AF AMP, AF OUT, VIDEO AMP,
Y/CHROMA AMP, LINE IN)

5 | 16 | 17 | 18 | 19 | 20 | 21 | 22 | 23 | 24 | 25 | 26 | 27 | 28 | 29 | 30 | 31

- B Board -

Q	IC	156 157 IC102 158	113 116	IC101	153 III	110	109 108	124	IC103	IC202 138	IC201 145	Q	IC	
D					121	002 001 101 104	105 104		003	004 005 148	006 007	008 151 009	010 149 000 116 117	D
ADJ						001			RV104 RV103	RV108 RV107	RV109 RV108	ADJ		

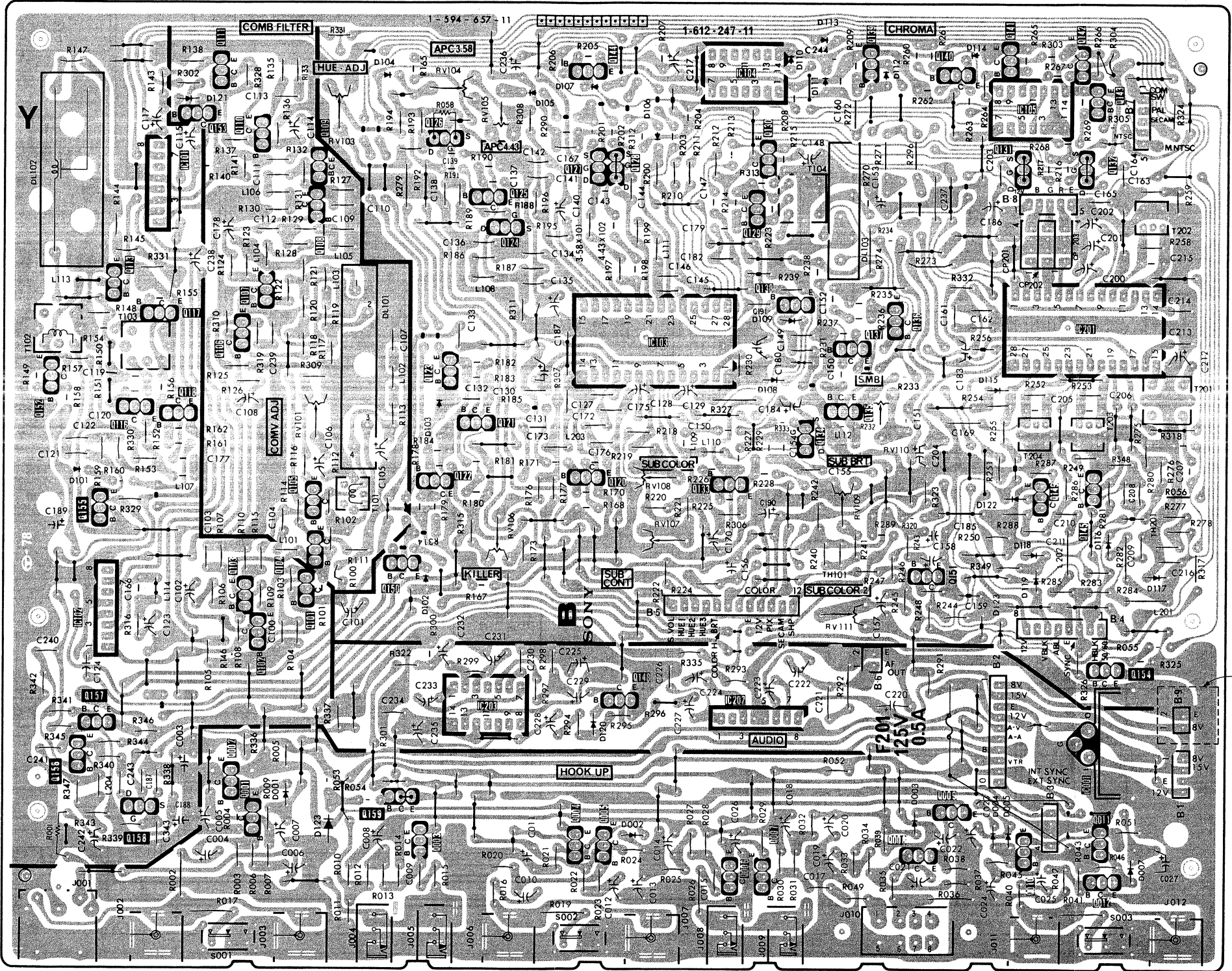
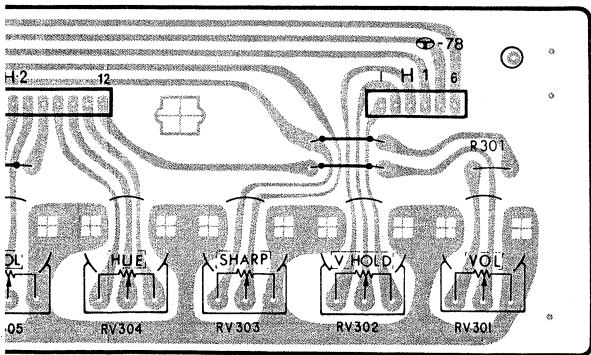

PVM-1911 ONLY

D V • H OSC, V AMP,
V OUT, PIN CORRECT

1 2 3 4 5 6 7 8 9 10 11 12 13 14 15

A
B
C
D
E
F
G
H
I

- D Board -

Q, IC	D	ADJ
850		
511, 510	524	520
502	521	
501	525	RV505
	508	
IC501	505	RV504
IC503	804	RV801
	507	RV802
	506	RV803
		RV503
		RV501
		RV502
	509	
	508	
IC504		
802		
IC801		
	514	RV507
801		
	510	RV500
	509	
	519	
IC505		
	511	
	512	RV506
	518	
	517	
	803	
	515	
	516	
512		
	513	
Q, IC	D	ADJ

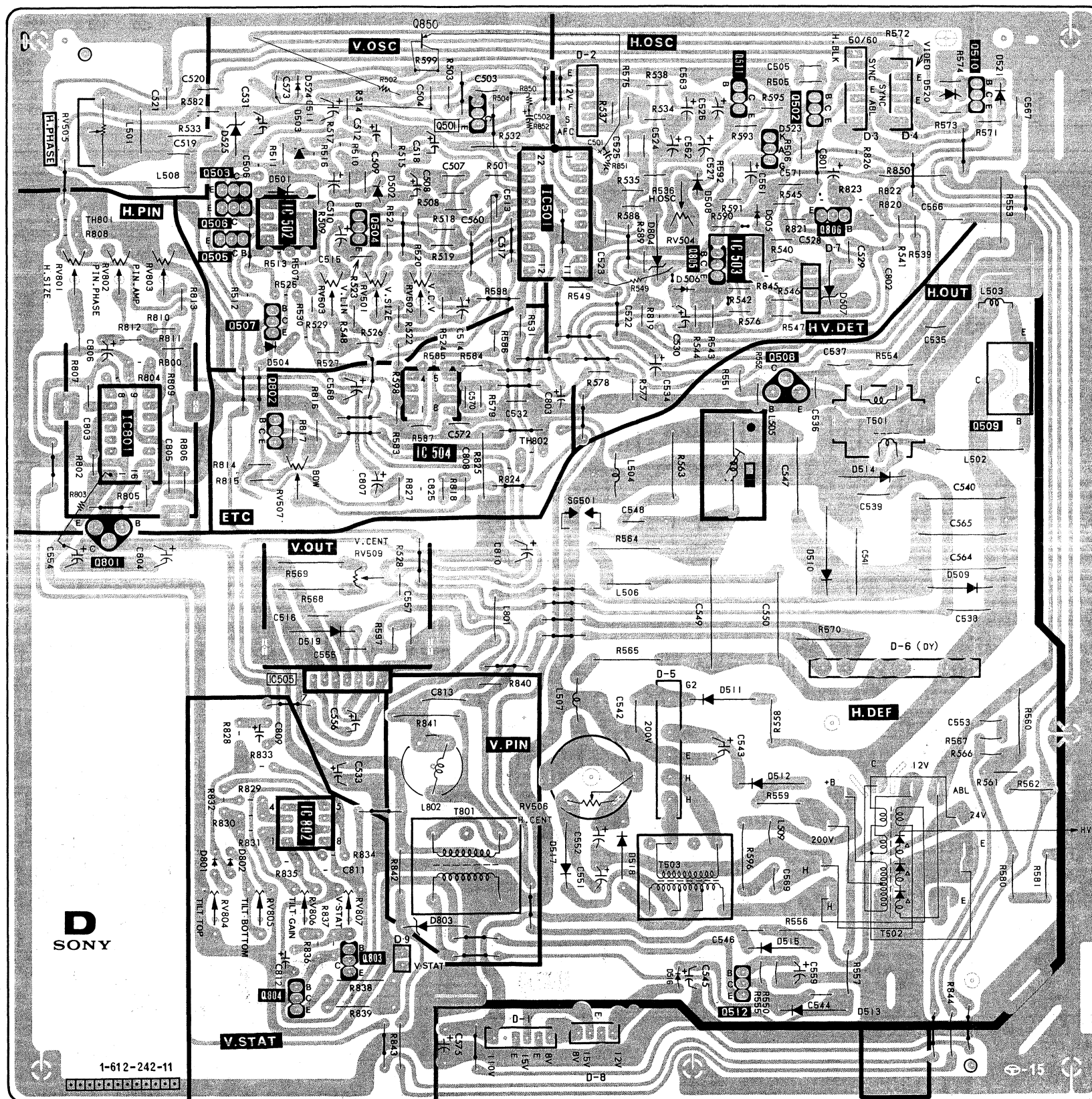

Q R • G • B PROCESS, CONTROL LOGIC,
SYNC OUT, R • G • B IN, AF IN, COMPTR IN

1 2 3 4 5 6 7 8 9 10 11 12 13 14 15

A - Q Board -

Q IC	456 455	REG402 REG401 IC403 431	426,425 424 423	IC408 IC407	411 410	409	IC406 429 415 414 IC409	430 419 418 417	IC405 IC404 433	454 453 452 450 457	449 448	445 446	442 447	443,444	Q IC	
D	404	425 419 422	420	408,407	408	409	410	423	424	437,436 416 412	435 414 411	403	401 402	404 403 402 401	D	
ADJ		418		405,406,407								RV401	RV405	RV404	RV403 RV402	ADJ

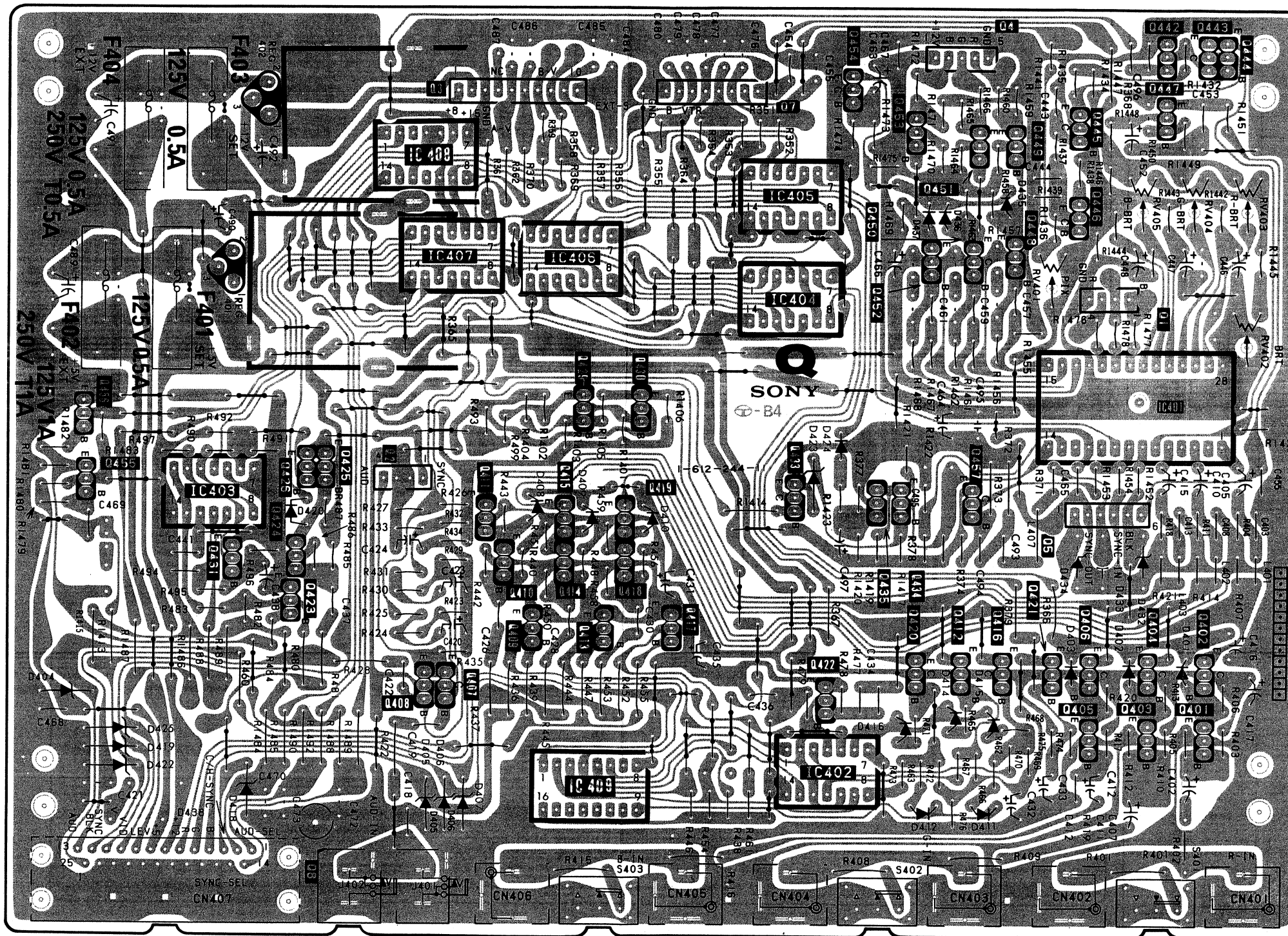

C1 (R · G · B OUT)

C2 (R · G · B DRIVE,
R · G · B BKG)

1 2 3 4 5 6 7

A
B
C
D
E
F
F
G
H
I

- C1 Board -

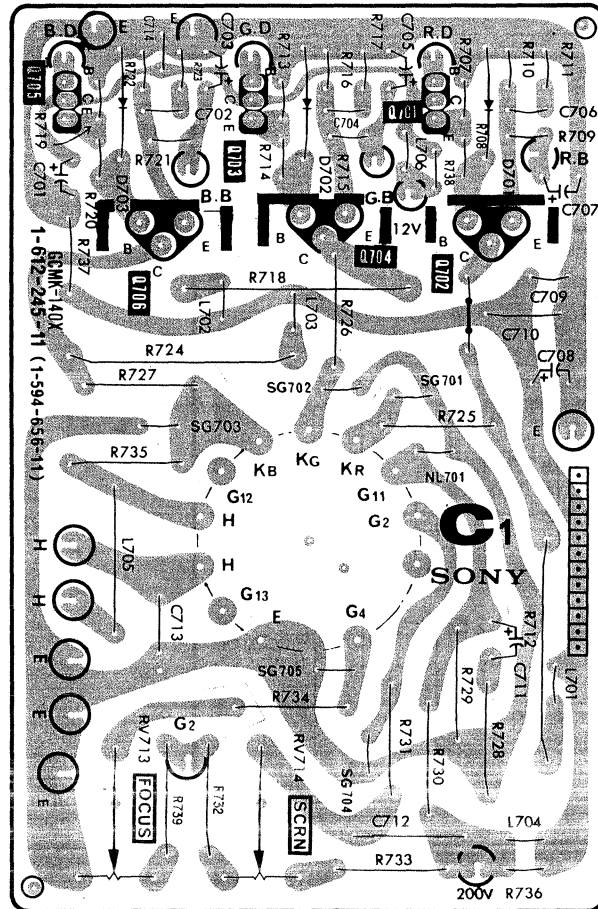

- C2 Board -

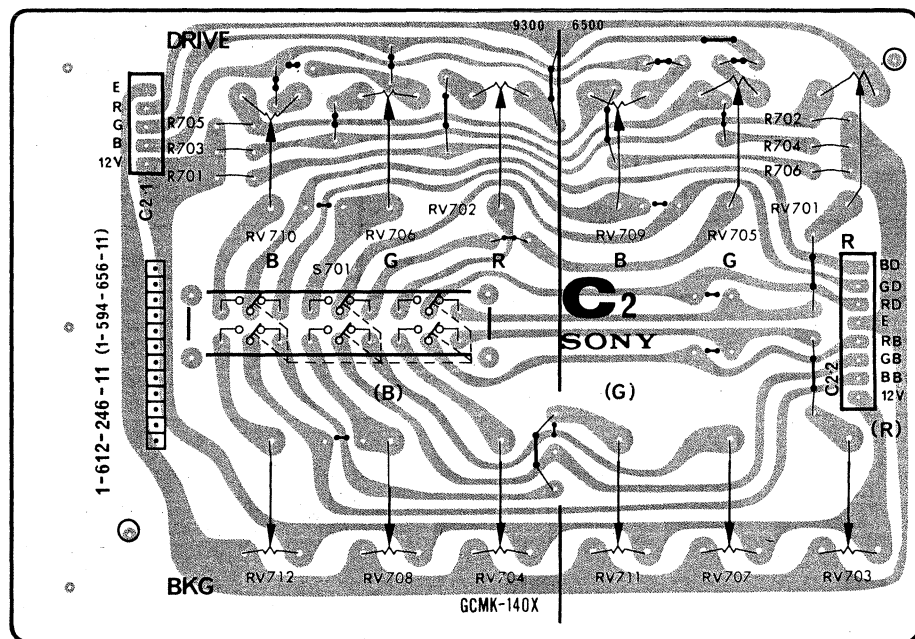

B BOARD

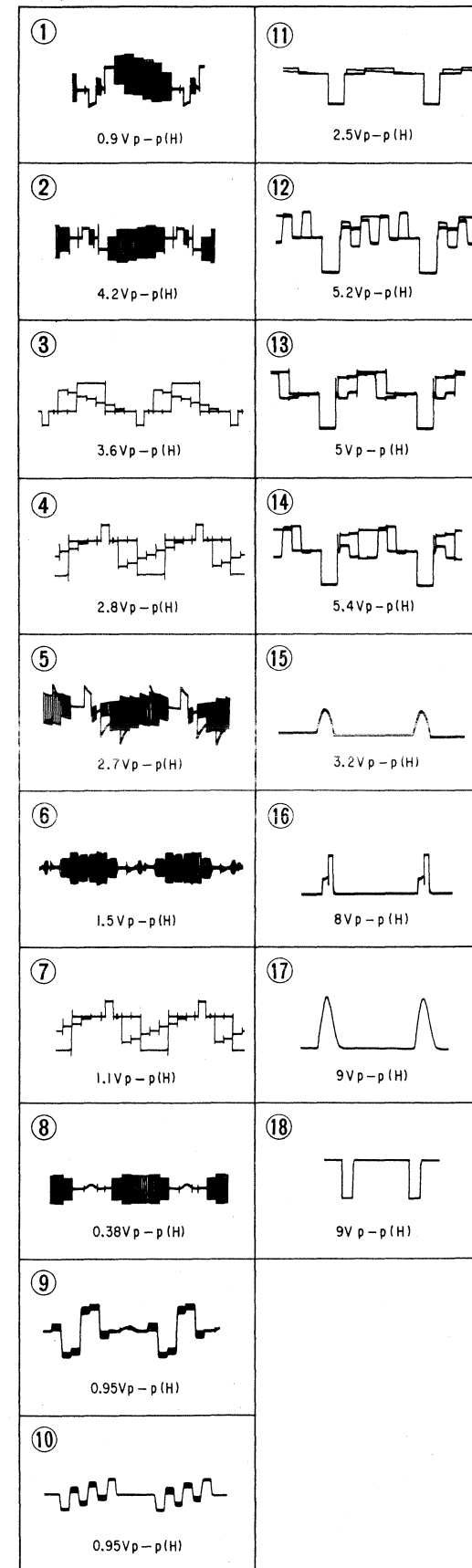

D BOARD

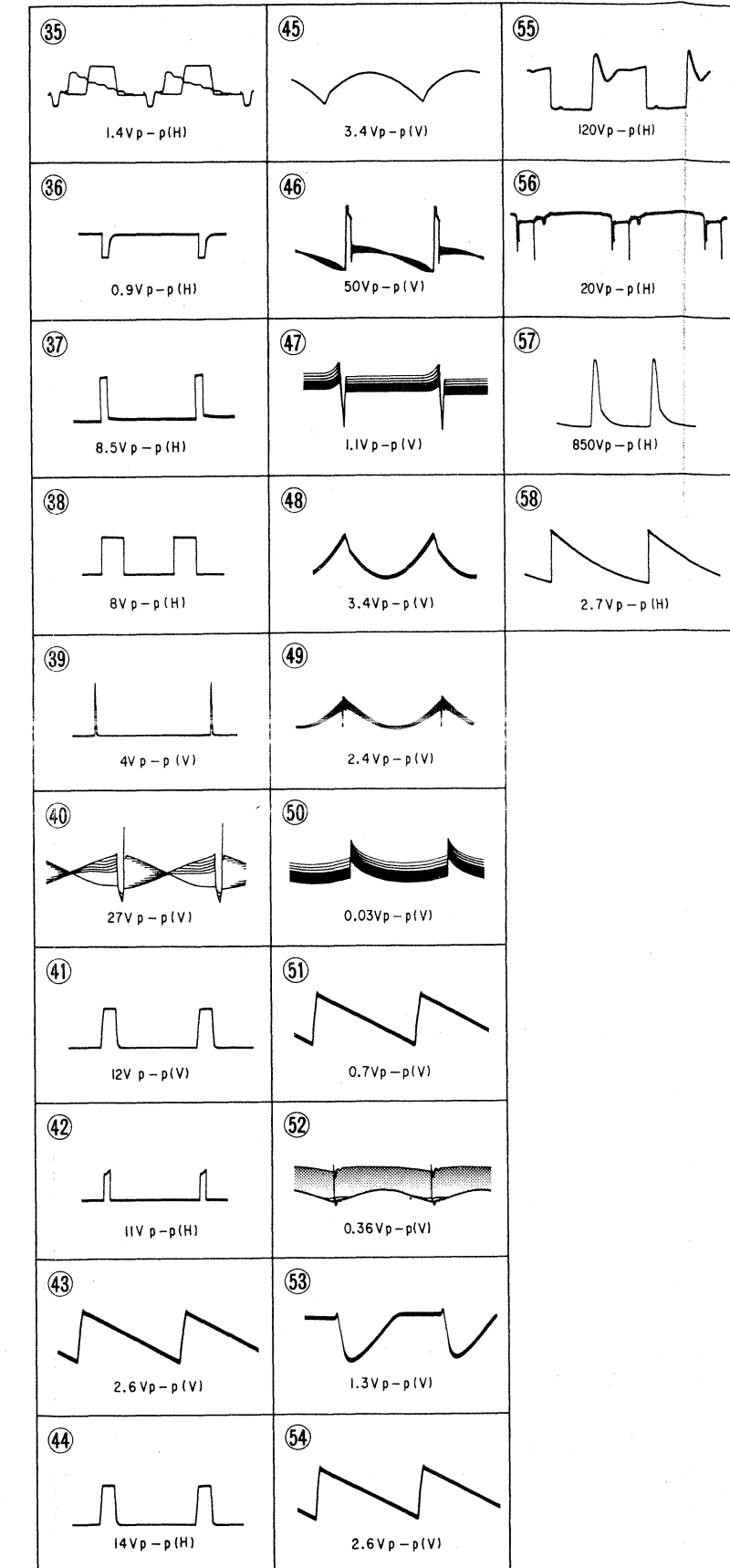

5-6. WAVEFORMS

B BOARD

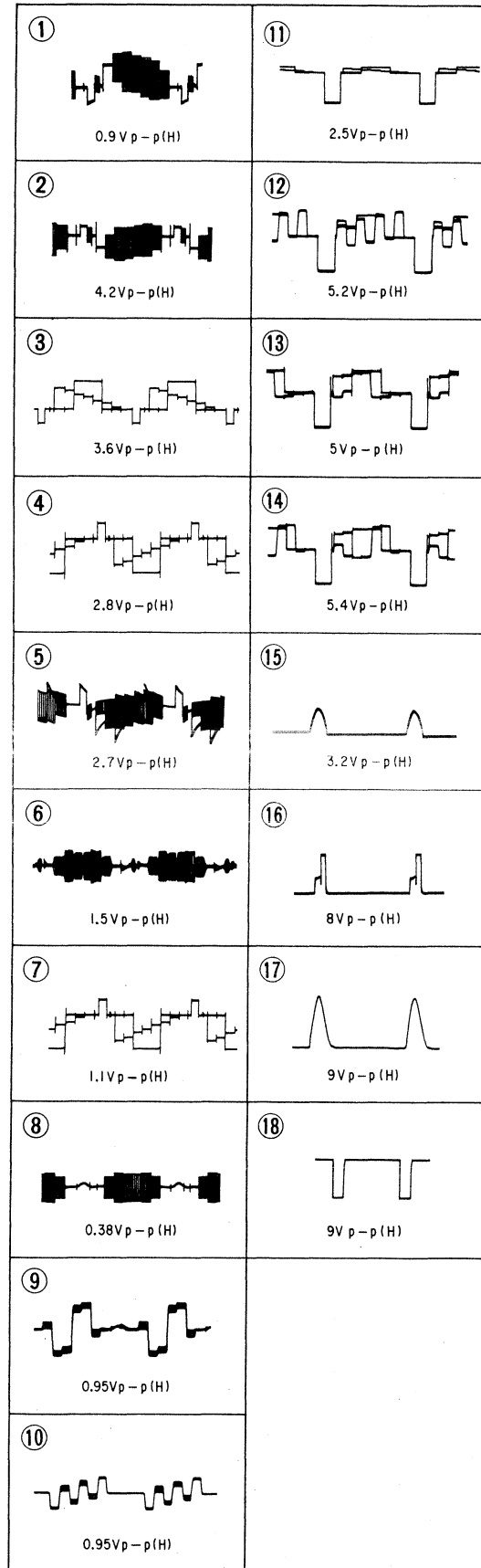

D BOARD

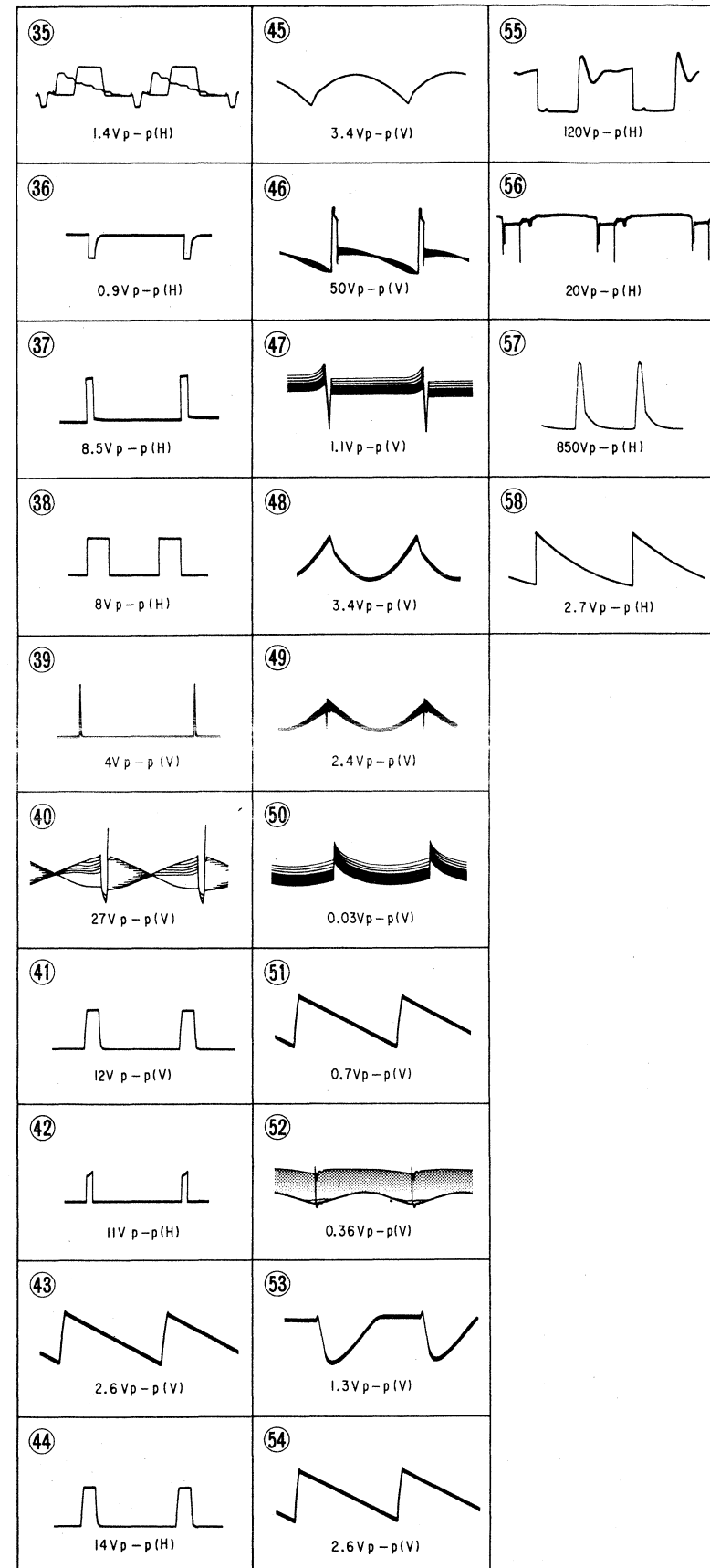

Q BOARD

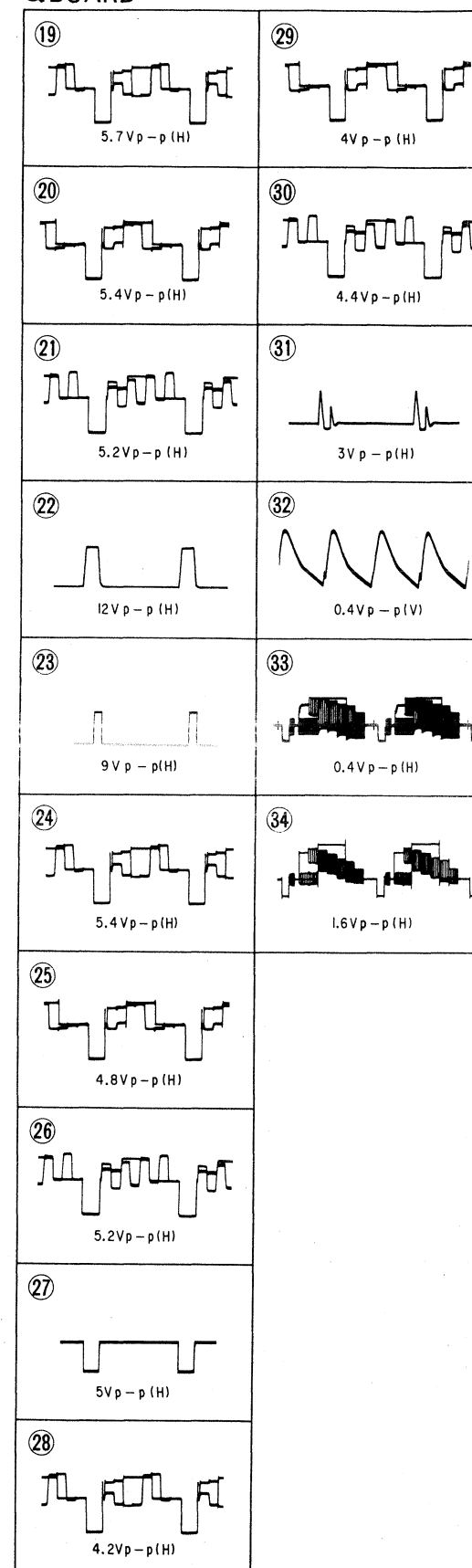

C1 BOARD

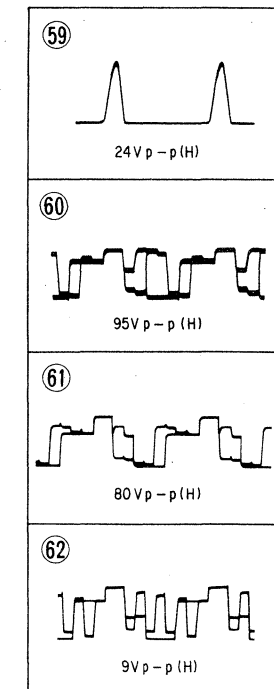

G BOARD

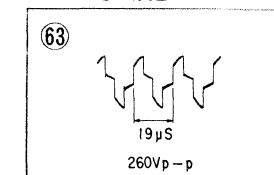

5-7. PRINTED WIRING BOARDS (PVM-1911 ONLY)

CN **M** (CONTROL)

— Conductor Side —

1 2 3 4 5 6 7 8 9 10 11 12 13 14 15 16

— CN Board —

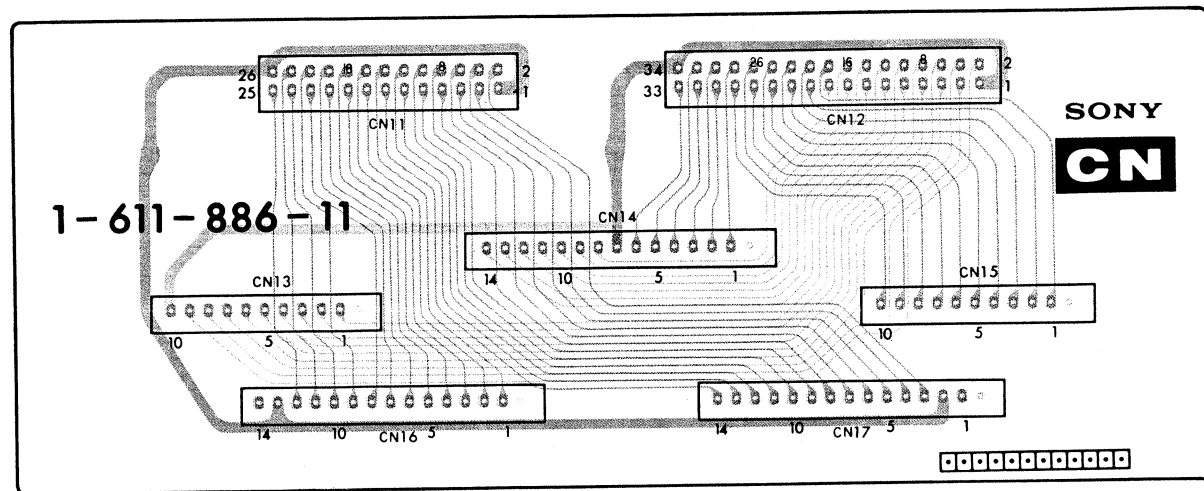

— M Board —

IC	IC18	IC17	IC16	IC14 IC15	IC13	IC12
D	5	4		3		
TP			5	6	7	

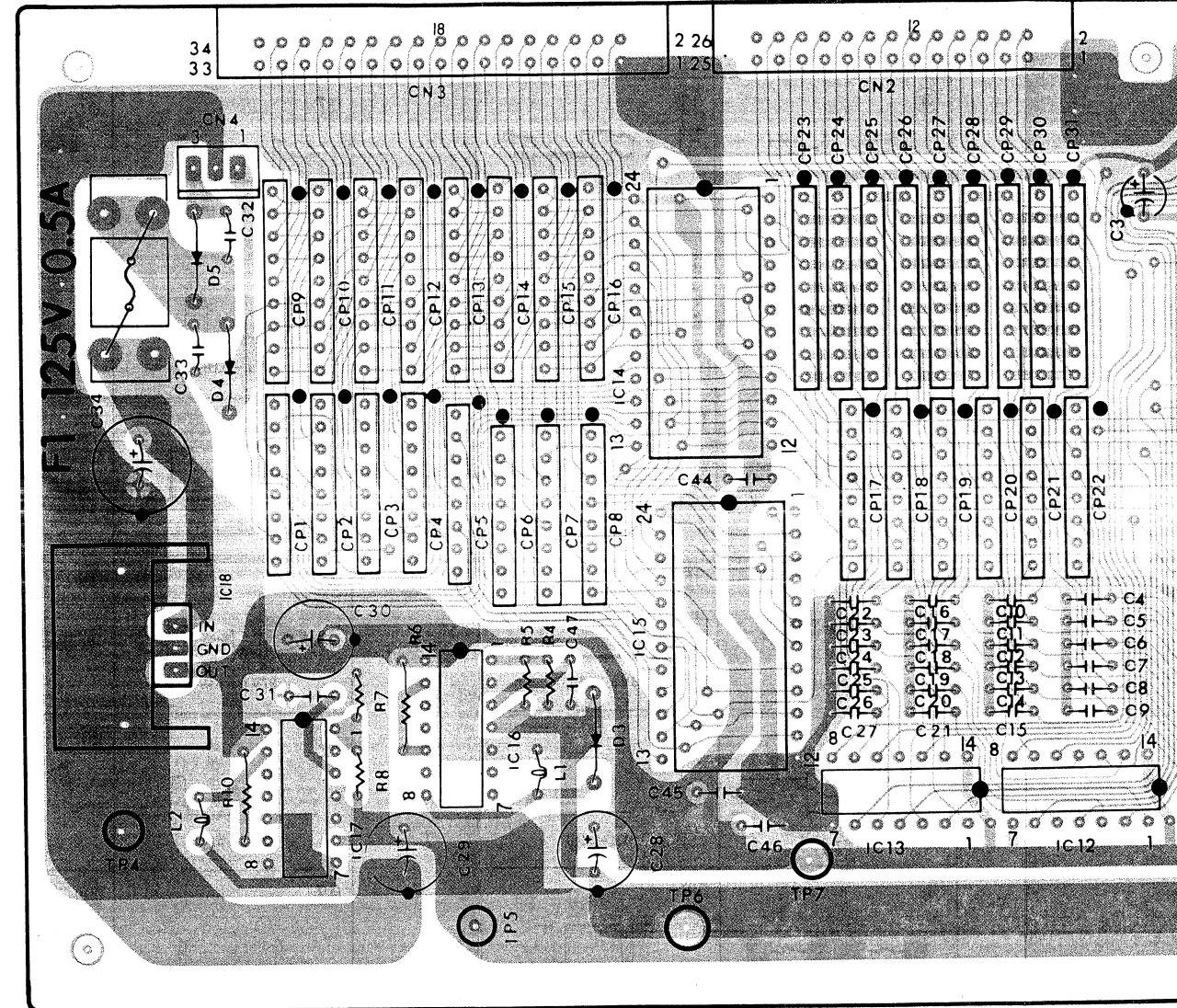

5-8. SEMICONDUCTORS (PVM-1911 ONLY)

CX564

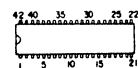

(Top view)

SN74LS123N

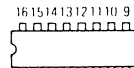

(Top view)

ERB12-02RK
GP08D

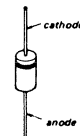

HD74LS154P
TL494ACN

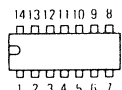

(Top view)

μPC78M05H

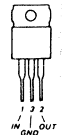

SIB01-02

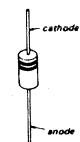

SN74LS04N
SN74LS86N
SN75188N
SN75189AN
TC40H004P
TC40H008P
TC40H032P

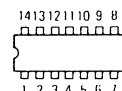

(Top view)

EM12

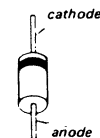

8 | 9 | 10 | 11 | 12 | 13 | 14 | 15 | 16 | 17 | 18 | 19 | 20 | 21 | 22

- M Board -

IC	IC18	IC17	IC16	IC14 IC15	IC13	IC12	IC9 IC10,IC11	IC8	IC6 IC7	IC4 IC5	IC1 IC2,IC3	IC
D	5	4		3				6				D
TP			5	6	7						1,2,3	TP

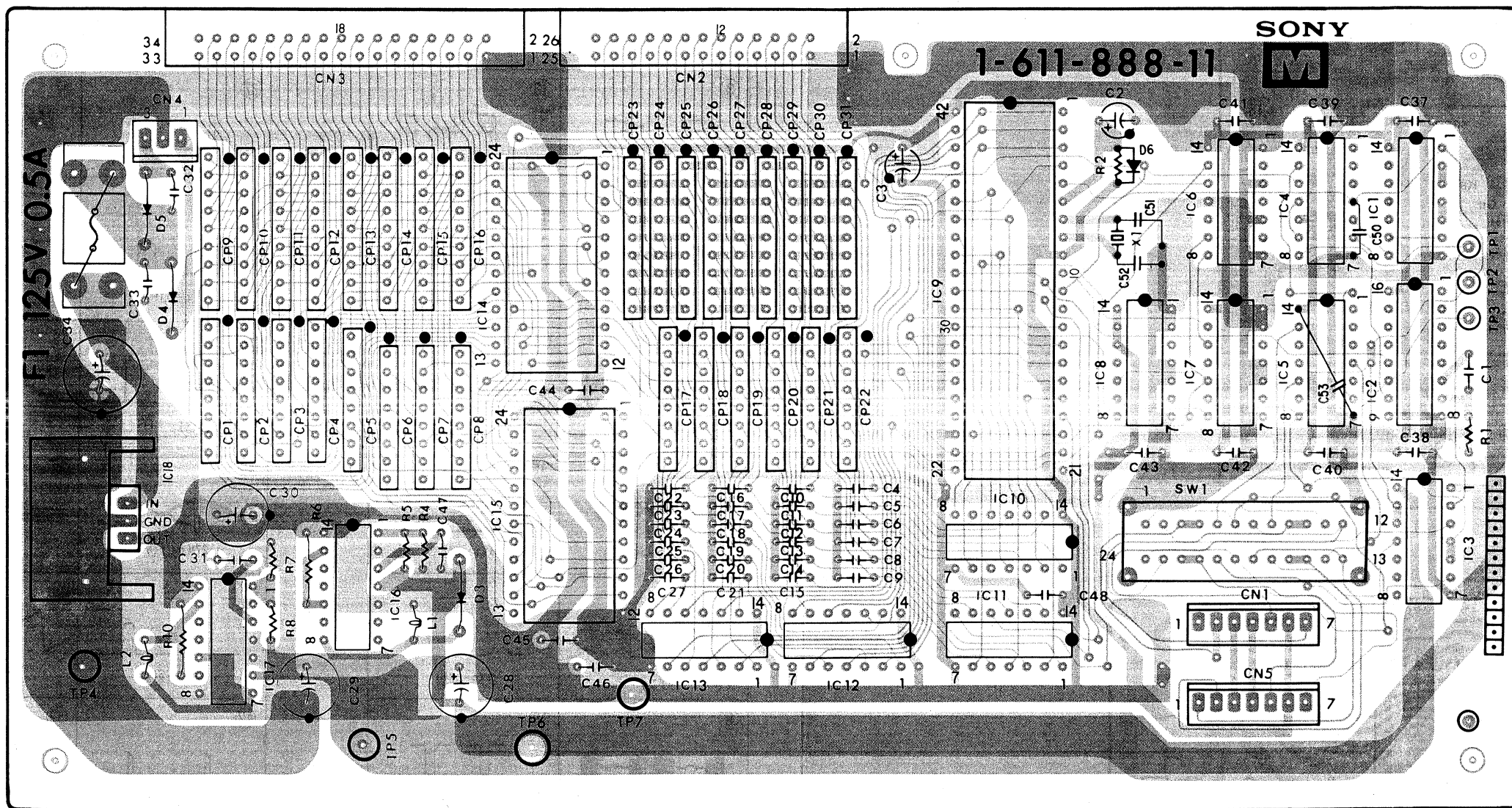



PVM-1910/1911 PVM-1910/1911

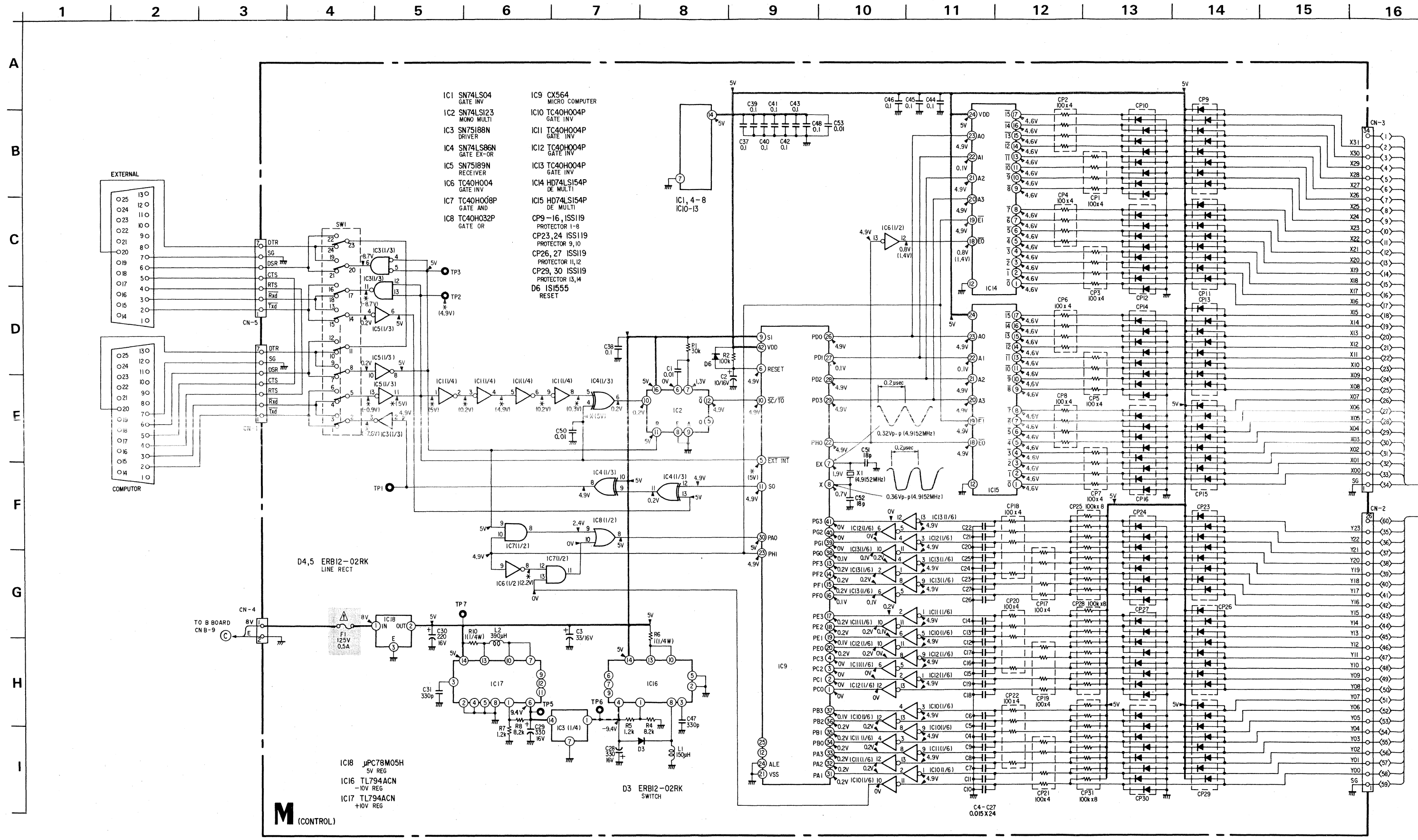

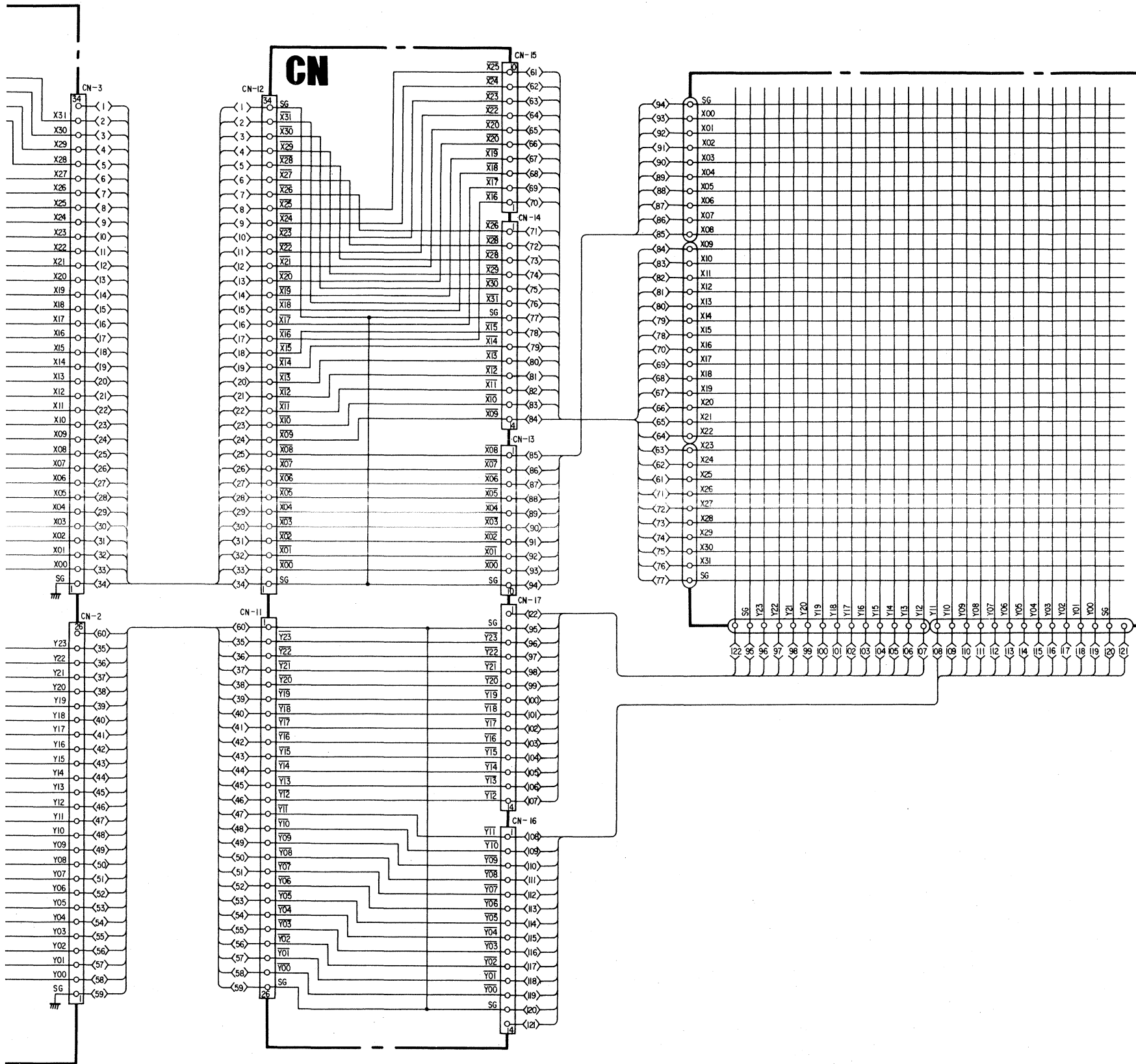
5.9. SCHEMATIC DIAGRAM (PVM-1911 ONLY)





Note: The components identified by shading and mark  are critical for safety. Replace only with part number specified.

Note: Les composants identifiés par un tramé et une marque  sont critiques pour la sécurité. Ne les remplacer que par une pièce portant le numéro spécifié.

- All capacitors are in μF unless otherwise noted. $\text{pF} : \mu\text{F}$ 50WV or less are not indicated except for electrolytics.
- All resistors are in ohms, $\frac{1}{8}\text{W}$ unless otherwise noted. $\text{k}\Omega : 1000\Omega$, $\text{M}\Omega : 1000\text{k}\Omega$
-  : panel designation.
- Voltages are dc with respect to ground unless otherwise noted.
- Readings are taken with a 10 $\text{M}\Omega$ digital multimeter.
no mark: normal signal input.
() : Ready mode.
- Voltage variations may be noted due to normal production tolerances.
-  B+ bus.
-  B- bus.

SECTION 6
EXPLODED VIEWS

NOTE:
• Items with no part number and no description are not stocked because they are seldom required for routine service.
• The construction parts of an assembled part are indicated with a collation number in the remark column.

• Items marked "▲" are not stocked since they are seldom required for routine service. Some delay should be anticipated when ordering these items.

The components identified by shading and mark ▲ are critical for safety. Replace only with part number specified.

Les composants identifiés par une trame et une marque ▲ sont critiques pour la sécurité. Ne les remplacer que par une pièce portant le numéro spécifié.

(1) CABINET ASS'Y

■ : TA, BV3 x 8 7-685-646-71

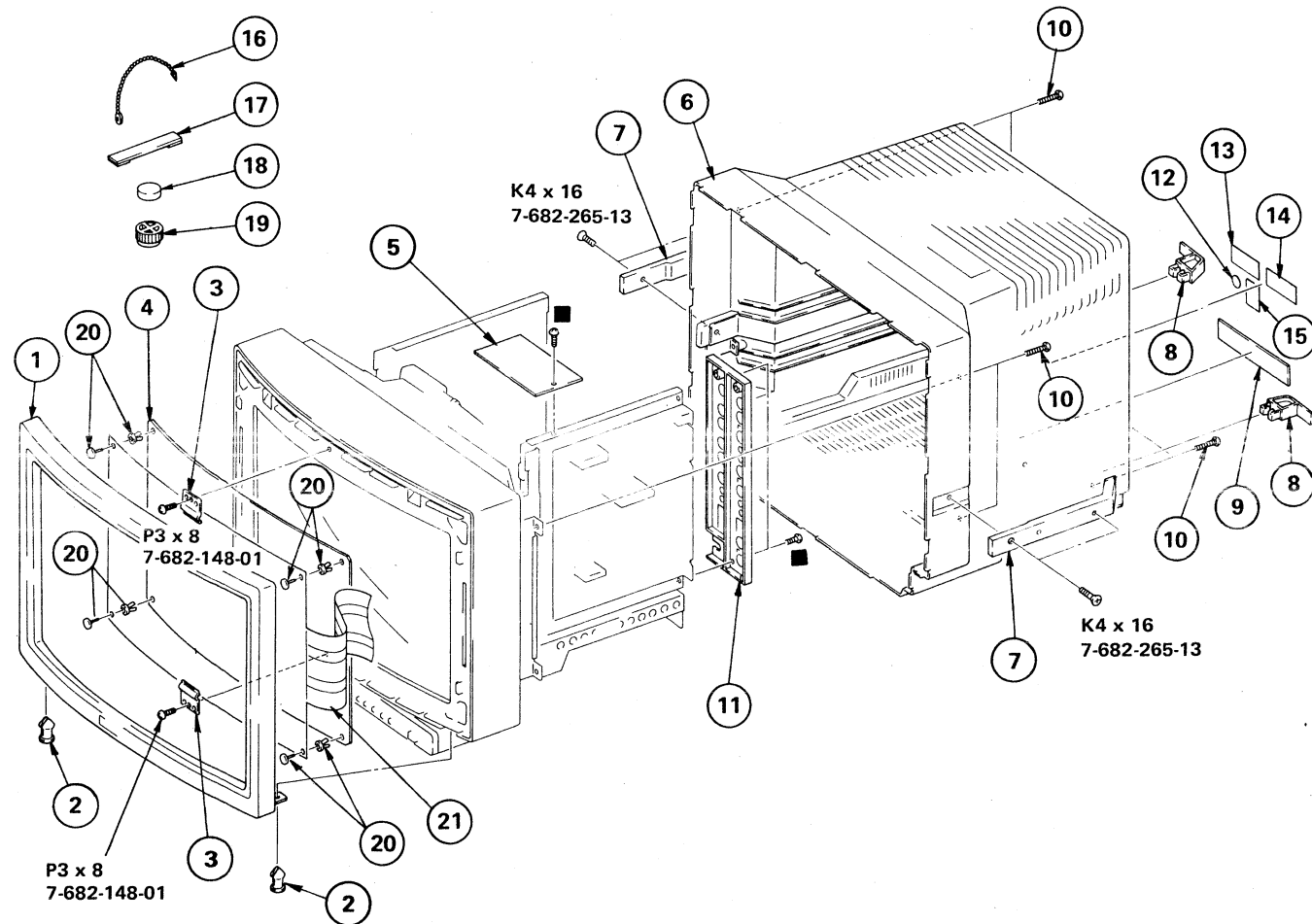

(2) CHASSIS ASS'Y

■ : TA, BV3 x 8 7-685-646-71

TA, BV4 x 8
7-685-659-11

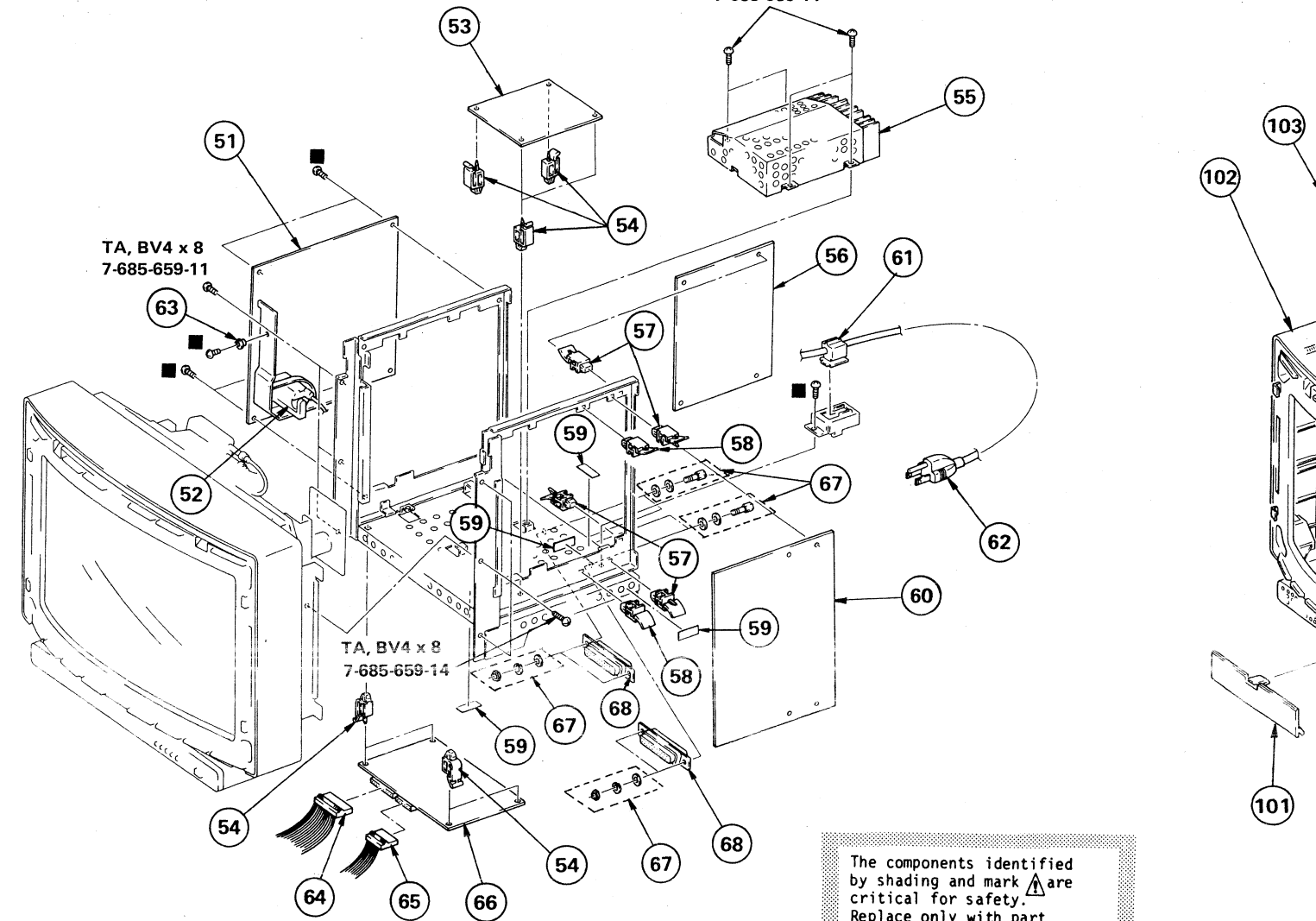

(3) BEZEL

● : TA, BV

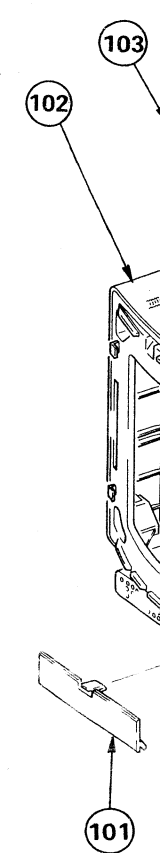

The components identified by shading and mark ▲ are critical for safety. Replace only with part number specified.

Les composants identifiés par une trame et une marque ▲ sont critiques pour la sécurité. Ne les remplacer que par une pièce portant le numéro spécifié.

No.	Part No.	Description	Remark	No.	Part No.	Description	Remark
1	X-4370-904-1	PANEL ASSY, FRONT		11	4-370-930-01	PANEL, CONNECTOR	
2	4-370-920-01	CLIP, PANEL		12	3-701-915-01	LABEL, UL	
3	4-370-902-01	RETAINER, PANEL		13	3-703-228-00	LABEL, CAUTION	
4	4-370-925-01	FILTER	(PVM-1910)	14	▲:4-370-911-01	LABEL, MODEL NUMBER (CANADA)	(PVM-1910)
4	4-370-925-11	FILTER	(PVM-1911)	14	▲:4-370-936-01	LABEL, MODEL NUMBER (CANADA)	(PCM-1911)
5	▲:1-612-246-11	C2 BOARD		15	4-010-023-00	LABEL, X-RAY	
6	X-4370-905-1	CABINET ASSY (PVM-1911)	7,8	16	4-308-870-00	CLIP, LEAD WIRE	
6	X-4370-903-1	CABINET ASSY (PVM-1910)	7,8,9	17	X-4308-815-0	PERMALLOY ASSY, CONVERGENCE	
7	X-4370-906-1	HANDLE ASSY		18	1-452-032-00	MAGNET DISK; 10MM Ø	
8	4-316-003-00	HOLDER, CORD		19	1-452-094-00	MAGNET, ROTATABLE DISK; 15MM Ø	
9	4-370-907-01	SHEET (B), BLIND	(PVM-1910 ONLY)	20	3-531-576-21	RIVET	(PVM-1911 ONLY)
10	4-304-494-21	SCREW, TAPPING, +PW4X16		21	1-554-847-11	PANEL, TOUCH	(PVM-1911 ONLY)

No.	Part No.	Description	Remark	No.	Part No.	Description	Remark	No.	Part No.	Description	Remark
51	▲:A-1345-456-A	D BOARD, COMPLETE		60	▲:A-1135-244-A	B BOARD, COMPLETE	(PVM-1911)	101	X-4370-		
52	▲:1-439-322-11	TRANSFORMER ASSY, FLYBACK		61	▲:4-364-726-01	BUSHING, AC CORD		102	X-4370-		
53	▲:1-612-243-11	F BOARD		62	▲:1-534-517-23	AC CORD		103	▲:4-364-7		
54	▲:3-659-681-00	HOLDER, PC BOARD		63	4-303-203-00	BUSHING		104	1-503-1		
55	▲:1-413-179-11	SWITCHING REGULATOR (TK-09)		64	1-557-318-11	CABLE, FLAT 34P	(PVM-1911 ONLY)	105	▲:4-321-6		
56	▲:A-1275-049-A	Q BOARD, COMPLETE		65	1-557-319-11	CABLE, FLAT 26P	(PVM-1911 ONLY)	106	▲:8-738-7		
57	▲:3-703-141-00	HOLDER, PCB		66	▲:A-1306-304-A	M BOARD, COMPLETE	(PVM-1911 ONLY)	107	4-348-E		
58	▲:4-321-929-00	HOLDER, PC BOARD		67	▲:4-603-275-00	LOCK, SCREW	(PVM-1911 ONLY)	108	3-703-C		
59	3-703-044-26	LABEL, CAUTION		68	1-557-330-11	CONNECTOR ASSY, CANON 25P	(PVM-1911 ONLY)	109	1-452-1		
60	▲:A-1135-240-A	B BOARD, COMPLETE	(PVM-1910)					110	▲:1-451-2		

SECTION 7
ELECTRICAL PARTS LIST

F Q

(3) BEZEL ASS'Y

●: TA, BV3 x 12 7-685-648-71

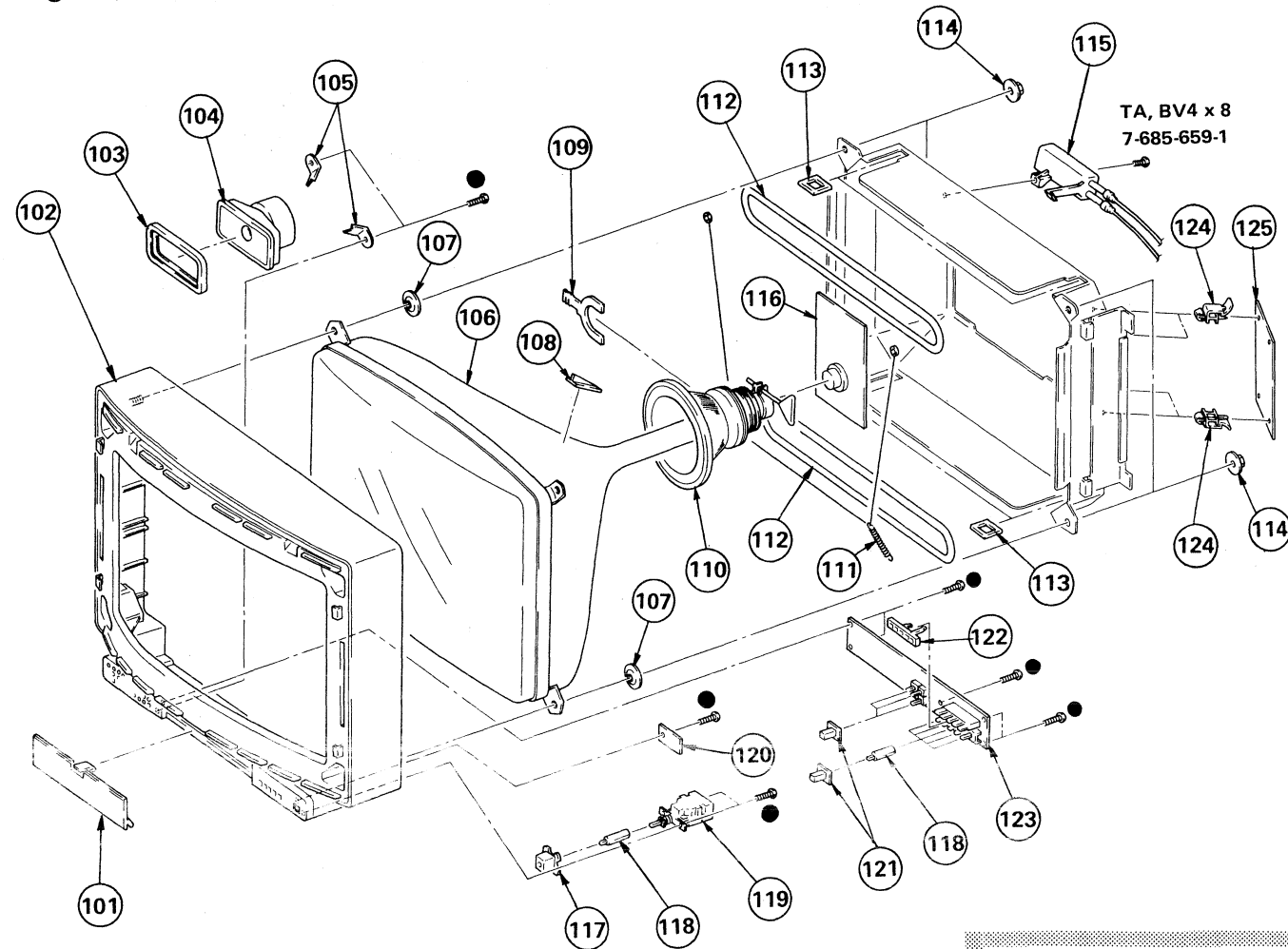

TA, BV4 x 8
7-685-659-1

The components identified by shading and mark Δ are critical for safety. Replace only with part number specified.

Les composants identifiés par une trame et une marque Δ sont critiques pour la sécurité. Ne les remplacer que par une pièce portant le numéro spécifié.

The components identified by shading and mark Δ are critical for safety. Replace only with part number specified.

Les composants identifiés par une trame et une marque Δ sont critiques pour la sécurité. Ne les remplacer que par une pièce portant le numéro spécifié.

Les composants identifiés par une trame et une marque Δ sont critiques pour la sécurité. Ne les remplacer que par une pièce portant le numéro spécifié.

• Items marked "▲" are not stocked since they are seldom required for routine service. Some delay should be anticipated when ordering these items.

When indicating parts by reference number, please include the board name.

• All variable and adjustable resistors have characteristic curve B, unless otherwise noted.

CAPACITORS
MF : μ F, PF : μ PF
COILS
MMH : mH, UH : μ H

RESISTORS
• All resistors are in ohms
• F : nonflammable

• The components identified by \square in this manual have been carefully factory-selected for each set in order to satisfy regulations regarding X-ray radiation. Should replacement be required, replace only with the value originally used.

Remark	No.	Part No.	Description	Remark	No.	Part No.	Description	Remark
	101	X-4370-907-1	DOOR ASSY		114	4-306-034-00	FLANGE NUT, (B) 5MM	
	102	X-4370-901-1	BEZEL ASSY	103,104,105	115	Δ 1-228-482-13	RESISTOR ASSY, HIGH-VOLTAGE	
	103	▲4-364-741-00	CUSHION, SPEAKER		116	▲A-1330-507-A	C1 BOARD, COMPLETE	
	104	1-503-109-00	SPEAKER		117	4-346-409-11	BUTTON, POWER	
911 ONLY)	105	▲4-321-611-00	CLAW, RETAINING, SPEAKER		118	▲4-370-903-01	SHAFT, BUTTON	
911 ONLY)	106	Δ 8-738-706-05	CRT (520SB22A)		119	Δ 1-553-584-12	SWITCH, PUSH (POWER)	
911 ONLY)	107	4-348-567-00	WASHER, CRT POSITION		120	▲1-612-249-11	X BOARD	
911 ONLY)	108	3-703-003-00	SPACER, DY		121	4-369-627-01	PUSH BUTTON	
911 ONLY)	109	1-452-146-00	MAGNET, BMC		122	▲4-370-919-01	CAP (5 GANG), LED HOLDER	
	110	Δ 1-451-204-61	DEFLECTION YOKE (SY-108B)		123	▲1-612-248-11	H BOARD	
	111	4-303-774-XX	SPRING		124	▲3-703-141-00	HOLDER, PCB	(PVM-1911 ONLY)
	112	Δ 1-426-087-41	COIL, DE GAUSSING		125	▲1-611-886-11	CN BOARD	(PVM-1911 ONLY)
	113	▲4-322-922-00	HOLDER, COIL, DE GAUSSER					

Ref.No	Part No.	Description	Remark	Ref.No	Part No.	Description	Remark
	▲:1-612-243-11	F BOARD		C405	1-123-380-00	ELECT	1MF 20% 50V
	*****			C407	1-123-356-00	ELECT	10MF 20% 25V
		CAPACITOR		C408	1-102-953-00	CERAMIC	18PF 5% 50V
C681	Δ 1-108-745-52	MYLAR	0.22MF 20% 125V	C410	1-123-380-00	ELECT	1MF 20% 50V
C682	Δ 1-108-745-52	MYLAR	0.22MF 20% 125V	C412	1-123-356-00	ELECT	10MF 20% 25V
C683	Δ 1-161-748-11	CERAMIC	0.0047MF 125V	C413	1-102-953-00	CERAMIC	18PF 5% 50V
C684	Δ 1-161-748-11	CERAMIC	0.0047MF 125V	C415	1-123-380-00	ELECT	1MF 20% 50V
C685	Δ 1-161-748-11	CERAMIC	0.0047MF 125V	C417	1-123-332-00	ELECT	47MF 20% 25V
				C419	1-106-212-00	MYLAR	0.047MF 10% 100V
C686	Δ 1-161-748-11	CERAMIC	0.0047MF 125V	C420	1-123-380-00	ELECT	1MF 20% 50V
C687	Δ 1-161-748-11	CERAMIC	0.0047MF 125V	C422	1-106-212-00	MYLAR	0.047MF 10% 100V
C688	Δ 1-161-748-11	CERAMIC	0.0047MF 125V	C423	1-123-380-00	ELECT	1MF 20% 50V
C689	1-125-320-00	ELECT (BLOCK)	820MF 200V	C424	1-123-332-00	ELECT	47MF 20% 25V
C690	1-125-320-00	ELECT (BLOCK)	820MF 200V	C426	1-123-234-00	ELECT	10MF 20% 50V
C691	1-102-085-00	CERAMIC	0.0047MF 500V	C428	1-123-234-00	ELECT	10MF 20% 50V
C692	1-102-085-00	CERAMIC	0.0047MF 500V	C430	1-123-234-00	ELECT	10MF 20% 50V
		DIODE		C432	1-123-332-00	ELECT	47MF 20% 25V
D681	8-719-911-55	DIODE U05G		C433	1-123-356-00	ELECT	10MF 20% 25V
D682	8-719-911-55	DIODE U05G		C434	1-102-773-00	CERAMIC	330PF 5% 50V
		CONNECTOR		C435	1-123-332-00	ELECT	47MF 20% 25V
F1	▲:1-506-348-XX	3P PLUG (L)		C436	1-101-006-00	CERAMIC	0.047MF 50V
F2	▲:1-508-765-00	3P PLUG (M)		C437	1-123-234-00	ELECT	10MF 20% 50V
F3	▲:1-508-765-00	3P PLUG (M)		C438	1-123-369-00	ELECT	4.7MF 20% 25V
		FUSE		C441	1-101-006-00	CERAMIC	0.047MF 50V
F601	Δ 1-532-221-11	FUSE 125V 5A		C443	1-106-212-00	MYLAR	0.047MF 10% 100V
	1-517-072-00	LAMP HOLDER, F601		C444	1-108-377-00	MYLAR	0.01MF 10% 100V
		RESISTOR		C446	1-123-380-00	ELECT	1MF 20% 50V
R681	1-214-947-00	METAL	2.7M 1% 1/2W	C447	1-123-380-00	ELECT	1MF 20% 50V
		TRANSFORMER		C448	1-123-380-00	ELECT	1MF 20% 50V
T651	Δ 1-421-556-21	TRANSFORMER, LINE FILTER (LFT)		C452	1-123-382-00	ELECT	3.3MF 20% 50V
T652	Δ 1-421-556-21	TRANSFORMER, LINE FILTER (LFT)		C453	1-123-228-00	ELECT	1MF 20% 50V
		THERMISTOR		C455	1-101-006-00	CERAMIC	0.047MF 50V
TH601	Δ 1-800-820-12	THERMISTOR, POWER		C457	1-102-773-00	CERAMIC	330PF 5% 50V
THP601	1-806-214-00	THERMISTOR, POSITIVE		C459	1-102-773-00	CERAMIC	330PF 5% 50V
		*****		C461	1-102-773-00	CERAMIC	330PF 5% 50V
	▲:A-1275-049-A	Q BOARD, COMPLETE		C463	1-123-356-00	ELECT	10MF 20% 25V
		*****		C464	1-123-332-00	ELECT	47MF 20% 25V
	1-536-843-11	TERMINAL BOARD, INPUT/OUTPUT (B)		C466	1-123-332-00	ELECT	47MF 20% 25V
	▲:4-603-275-00	LOCK, SCREW		C467	1-101-006-00	CERAMIC	0.047MF 50V
		CAPACITOR		C468	1-101-006-00	CERAMIC	0.047MF 50V
C402	1-123-356-00	ELECT	10MF 20% 25V	C469	1-108-377-00	MYLAR	0.01MF 10% 100V
C403	1-102-953-00	CERAMIC	18PF 5% 50V	C489	1-123-332-00	ELECT	47MF 20% 25V
		CONNECTOR		C490	1-123-332-00	ELECT	47MF 20% 25V
CN407	▲:1-562-243-00	CONNECTOR 25P		C491	1-123-332-00	ELECT	47MF 20% 25V
				C492	1-123-332-00	ELECT	47MF 20% 25V
				C493	1-102-766-00	CERAMIC	150PF 5% 50V
				C494	1-108-377-00	MYLAR	0.01MF 10% 100V
				C495	1-101-006-00	CERAMIC	0.047MF 50V
				C497	1-123-356-00	ELECT	10MF 20% 25V

Ref.No	Part No.	Description	Remark	Ref.No	Part No.	Description	Remark
<u>DIODE</u>							
D401	8-719-911-19	DIODE 1SS119		Q2	▲:1-560-124-00	PLUG, CONNECTOR (2.5MM) 4P	
D402	8-719-911-19	DIODE 1SS119		Q3	▲:1-560-224-00	PLUG, CONNECTOR (2.5MM) 10P	
D403	8-719-911-19	DIODE 1SS119		Q4	▲:1-560-125-00	PLUG, CONNECTOR (2.5MM) 5P	
D404	8-719-100-37	DIODE RD6.2E-B1		Q5	▲:1-560-126-00	PLUG, CONNECTOR (2.5MM) 6P	
D405	8-719-100-37	DIODE RD6.2E-B1		Q7	▲:1-560-128-00	PLUG, CONNECTOR (2.5MM PITCH)	
				<u>TRANSISTOR</u>			
D406	8-719-100-37	DIODE RD6.2E-B1		Q401	8-729-204-83	TRANSISTOR 2SA1048-GR	
D407	8-719-100-37	DIODE RD6.2E-B1		Q402	8-729-245-83	TRANSISTOR 2SC2458	
D408	8-719-911-19	DIODE 1SS119		Q403	8-729-204-83	TRANSISTOR 2SA1048-GR	
D409	8-719-911-19	DIODE 1SS119		Q404	8-729-245-83	TRANSISTOR 2SC2458	
D410	8-719-911-19	DIODE 1SS119		Q405	8-729-204-83	TRANSISTOR 2SA1048-GR	
D411	8-719-911-19	DIODE 1SS119		Q406	8-729-245-83	TRANSISTOR 2SC2458	
D412	8-719-911-19	DIODE 1SS119		Q407	8-729-204-83	TRANSISTOR 2SA1048-GR	
D414	8-719-911-19	DIODE 1SS119		Q408	8-729-204-83	TRANSISTOR 2SA1048-GR	
D415	8-719-911-19	DIODE 1SS119		Q409	8-729-245-83	TRANSISTOR 2SC2458	
D416	8-719-911-19	DIODE 1SS119		Q410	8-729-204-83	TRANSISTOR 2SA1048-GR	
D418	8-719-100-37	DIODE RD6.2E-B1		Q411	8-729-245-83	TRANSISTOR 2SC2458	
D419	8-719-100-37	DIODE RD6.2E-B1		Q412	8-729-245-83	TRANSISTOR 2SC2458	
D420	8-719-911-19	DIODE 1SS119		Q413	8-729-245-83	TRANSISTOR 2SC2458	
D422	8-719-100-37	DIODE RD6.2E-B1		Q414	8-729-204-83	TRANSISTOR 2SA1048-GR	
D423	8-719-100-22	DIODE RD4.3E-B1		Q415	8-729-245-83	TRANSISTOR 2SC2458	
D424	8-719-911-19	DIODE 1SS119		Q416	8-729-245-83	TRANSISTOR 2SC2458	
D425	8-719-100-26	DIODE RD4.7E-B1		Q417	8-729-245-83	TRANSISTOR 2SC2458	
D435	8-719-911-19	DIODE 1SS119		Q418	8-729-204-83	TRANSISTOR 2SA1048-GR	
D436	8-719-911-19	DIODE 1SS119		Q419	8-729-245-83	TRANSISTOR 2SC2458	
D437	8-719-911-19	DIODE 1SS119		Q420	8-729-245-83	TRANSISTOR 2SC2458	
<u>FUSE</u>							
F401	▲.1-532-580-00	FUSE, GLASS TUBE 125V 0.5A		Q421	8-729-245-83	TRANSISTOR 2SC2458	
F402	▲.1-532-536-00	FUSE, GLASS-TUBE 125V 1A		Q422	8-729-245-83	TRANSISTOR 2SC2458	
F403	▲.1-532-580-00	FUSE, GLASS TUBE 125V 0.5A		Q423	8-729-245-83	TRANSISTOR 2SC2458	
F404	▲.1-532-580-00	FUSE, GLASS TUBE 125V 0.5A		Q424	8-729-204-83	TRANSISTOR 2SA1048-GR	
	1-533-087-00	HOLDER, FUSE, F401, F402, F403, F404		Q425	8-729-245-83	TRANSISTOR 2SC2458	
<u>IC</u>							
IC401	8-752-201-90	IC CX22019		Q426	8-729-245-83	TRANSISTOR 2SC2458	
IC402	8-759-900-09	IC SN74LS09N		Q429	8-729-245-83	TRANSISTOR 2SC2458	
IC403	8-759-901-36	IC SN74LS136N		Q430	8-729-204-83	TRANSISTOR 2SA1048-GR	
IC404	8-759-900-08	IC SN74LS08N		Q431	8-729-245-83	TRANSISTOR 2SC2458	
IC405	8-759-900-08	IC SN74LS08N		Q433	8-729-204-83	TRANSISTOR 2SA1048-GR	
IC406	8-759-900-04	IC SN74LS04N		Q434	8-729-204-83	TRANSISTOR 2SA1048-GR	
IC407	8-759-900-00	IC SN74LS00N		Q435	8-729-204-83	TRANSISTOR 2SA1048-GR	
IC408	8-759-900-20	IC SN74LS20N		Q442	8-729-245-83	TRANSISTOR 2SC2458	
IC409	8-759-901-38	IC SN74LS138N		Q443	8-729-245-83	TRANSISTOR 2SC2458	
<u>COIL</u>							
L401	1-408-412-00	MICRO INDUCTOR 18UH		Q444	8-729-245-83	TRANSISTOR 2SC2458	
L402	1-408-412-00	MICRO INDUCTOR 18UH		Q445	8-729-204-83	TRANSISTOR 2SA1048-GR	
L403	1-408-412-00	MICRO INDUCTOR 18UH		Q446	8-729-204-83	TRANSISTOR 2SA1048-GR	
L407	1-408-163-00	MICRO INDUCTOR 5.6MMH		Q447	8-729-245-83	TRANSISTOR 2SC2458	
<u>CONNECTOR</u>							
Q1	▲:1-560-124-00	PLUG, CONNECTOR (2.5MM) 4P		Q448	8-729-204-83	TRANSISTOR 2SA1048-GR	
				Q449	8-729-245-83	TRANSISTOR 2SC2458	
				Q450	8-729-204-83	TRANSISTOR 2SA1048-GR	
				Q451	8-729-245-83	TRANSISTOR 2SC2458	
				Q452	8-729-204-83	TRANSISTOR 2SA1048-GR	
				Q453	8-729-245-83	TRANSISTOR 2SC2458	
				Q454	8-729-204-83	TRANSISTOR 2SA1048-GR	
				Q455	8-729-245-83	TRANSISTOR 2SC2458	

The components identified by shading and mark ▲ are critical for safety. Replace only with part number specified.

Les composants identifiés par une trame et une marque ▲ sont critiques pour la sécurité. Ne les remplacer que par une pièce portant le numéro spécifié.

Q

Ref.No	Part No.	Description	Remark	Ref.No	Part No.	Description	Remark
Q456	8-729-245-83	TRANSISTOR ZSC2458		R425	1-247-871-00	CARBON 47K 5%	1/6W
Q457	8-729-204-83	TRANSISTOR ZSA1048-GR		R426	1-247-851-00	CARBON 6.8K 5%	1/6W
<u>RESISTOR</u>				R427	1-247-847-00	CARBON 4.7K 5%	1/6W
R351	1-247-855-00	CARBON 10K 5%	1/6W	R428	1-246-515-00	CARBON 56K 5%	1/4W
R352	1-247-815-00	CARBON 220 5%	1/6W	R429	1-247-885-00	CARBON 180K 5%	1/6W
R353	1-247-855-00	CARBON 10K 5%	1/6W	R430	1-247-877-00	CARBON 82K 5%	1/6W
R354	1-247-815-00	CARBON 220 5%	1/6W	R431	1-247-871-00	CARBON 47K 5%	1/6W
R355	1-247-807-00	CARBON 100 5%	1/6W	R432	1-247-851-00	CARBON 6.8K 5%	1/6W
R356	1-246-469-00	CARBON 680 5%	1/4W	R433	1-247-847-00	CARBON 4.7K 5%	1/6W
R357	1-246-469-00	CARBON 680 5%	1/4W	R434	1-247-807-00	CARBON 100 5%	1/6W
R358	1-247-827-00	CARBON 680 5%	1/6W	R435	1-247-879-00	CARBON 100K 5%	1/6W
R359	1-247-827-00	CARBON 680 5%	1/6W	R436	1-247-103-00	CARBON 68 5%	1/4W
R361	1-246-469-00	CARBON 680 5%	1/4W	R437	1-246-473-00	CARBON 1K 5%	1/4W
R362	1-246-469-00	CARBON 680 5%	1/4W	R438	1-247-839-00	CARBON 2.2K 5%	1/6W
R364	1-247-827-00	CARBON 680 5%	1/6W	R439	1-246-497-00	CARBON 10K 5%	1/4W
R365	1-246-469-00	CARBON 680 5%	1/4W	R440	1-247-878-00	CARBON 91K 5%	1/6W
R366	1-246-457-00	CARBON 220 5%	1/4W	R442	1-247-865-00	CARBON 27K 5%	1/6W
R367	1-246-457-00	CARBON 220 5%	1/4W	R443	1-247-853-00	CARBON 8.2K 5%	1/6W
R368	1-247-855-00	CARBON 10K 5%	1/6W	R444	1-247-103-00	CARBON 68 5%	1/4W
R369	1-247-815-00	CARBON 220 5%	1/6W	R445	1-246-473-00	CARBON 1K 5%	1/4W
R370	1-247-815-00	CARBON 220 5%	1/6W	R446	1-247-839-00	CARBON 2.2K 5%	1/6W
R371	1-247-843-00	CARBON 3.3K 5%	1/6W	R447	1-246-497-00	CARBON 10K 5%	1/4W
R372	1-246-485-00	CARBON 3.3K 5%	1/4W	R448	1-247-878-00	CARBON 91K 5%	1/6W
R373	1-246-537-00	CARBON 470K 5%	1/4W	R450	1-247-865-00	CARBON 27K 5%	1/6W
R374	1-247-871-00	CARBON 47K 5%	1/6W	R451	1-247-853-00	CARBON 8.2K 5%	1/6W
R377	1-247-845-00	CARBON 3.9K 5%	1/6W	R452	1-247-103-00	CARBON 68 5%	1/4W
R378	1-247-855-00	CARBON 10K 5%	1/6W	R453	1-246-473-00	CARBON 1K 5%	1/4W
R379	1-246-469-00	CARBON 680 5%	1/4W	R454	1-247-839-00	CARBON 2.2K 5%	1/6W
R401	1-247-104-00	CARBON 75 5%	1/4W	R455	1-246-497-00	CARBON 10K 5%	1/4W
R402	1-246-473-00	CARBON 1K 5%	1/4W	R456	1-247-878-00	CARBON 91K 5%	1/6W
R403	1-247-878-00	CARBON 91K 5%	1/6W	R458	1-247-865-00	CARBON 27K 5%	1/6W
R404	1-247-831-00	CARBON 1K 5%	1/6W	R459	1-247-853-00	CARBON 8.2K 5%	1/6W
R405	1-247-865-00	CARBON 27K 5%	1/6W	R460	1-247-107-00	CARBON 100 5%	1/4W
R406	1-247-853-00	CARBON 8.2K 5%	1/6W	R461	1-247-839-00	CARBON 2.2K 5%	1/6W
R407	1-247-831-00	CARBON 1K 5%	1/6W	R462	1-247-831-00	CARBON 1K 5%	1/6W
R408	1-247-104-00	CARBON 75 5%	1/4W	R462	1-247-845-00	CARBON 3.9K 5%	1/6W
R409	1-246-473-00	CARBON 1K 5%	1/4W	R465	1-247-835-00	CARBON 1.5K 5%	1/6W
R410	1-247-878-00	CARBON 91K 5%	1/6W	R466	1-247-819-00	CARBON 330 5%	1/6W
R411	1-247-831-00	CARBON 1K 5%	1/6W	R467	1-247-829-00	CARBON 820 5%	1/6W
R412	1-247-865-00	CARBON 27K 5%	1/6W	R468	1-247-835-00	CARBON 1.5K 5%	1/6W
R413	1-247-853-00	CARBON 8.2K 5%	1/6W	R469	1-247-819-00	CARBON 330 5%	1/6W
R414	1-247-831-00	CARBON 1K 5%	1/6W	R470	1-247-829-00	CARBON 820 5%	1/6W
R415	1-247-104-00	CARBON 75 5%	1/4W	R471	1-247-835-00	CARBON 1.5K 5%	1/6W
R416	1-246-473-00	CARBON 1K 5%	1/4W	R472	1-247-819-00	CARBON 330 5%	1/6W
R417	1-247-878-00	CARBON 91K 5%	1/6W	R473	1-247-829-00	CARBON 820 5%	1/6W
R418	1-247-831-00	CARBON 1K 5%	1/6W	R474	1-247-847-00	CARBON 4.7K 5%	1/6W
R419	1-247-865-00	CARBON 27K 5%	1/6W	R475	1-247-853-00	CARBON 8.2K 5%	1/6W
R420	1-247-853-00	CARBON 8.2K 5%	1/6W	R476	1-247-831-00	CARBON 1K 5%	1/6W
R421	1-247-831-00	CARBON 1K 5%	1/6W	R477	1-247-847-00	CARBON 4.7K 5%	1/6W
R422	1-246-515-00	CARBON 56K 5%	1/4W	R478	1-247-847-00	CARBON 4.7K 5%	1/6W
R423	1-247-885-00	CARBON 180K 5%	1/6W	R479	1-247-847-00	CARBON 4.7K 5%	1/6W
R424	1-247-877-00	CARBON 82K 5%	1/6W	R480	1-247-103-00	CARBON 68 5%	1/4W
				R481	1-246-481-00	CARBON 2.2K 5%	1/4W



Ref.No	Part No.	Description	Remark	Ref.No	Part No.	Description	Remark
R482	1-247-839-00	CARBON	2.2K 5% 1/6W	R1456	1-247-823-00	CARBON	470 5% 1/6W
R483	1-247-807-00	CARBON	100 5% 1/6W	R1457	1-247-839-00	CARBON	2.2K 5% 1/6W
R484	1-247-855-00	CARBON	10K 5% 1/6W	R1458	1-247-799-00	CARBON	47 5% 1/6W
R485	1-247-878-00	CARBON	91K 5% 1/6W	R1459	1-247-825-00	CARBON	560 5% 1/6W
R486	1-247-865-00	CARBON	27K 5% 1/6W	R1460	1-247-791-00	CARBON	22 5% 1/6W
R487	1-247-853-00	CARBON	8.2K 5% 1/6W	R1461	1-247-839-00	CARBON	2.2K 5% 1/6W
R488	1-246-457-00	CARBON	220 5% 1/4W	R1462	1-247-823-00	CARBON	470 5% 1/6W
R489	1-246-489-00	CARBON	4.7K 5% 1/4W	R1463	1-247-839-00	CARBON	2.2K 5% 1/6W
R490	1-247-835-00	CARBON	1.5K 5% 1/6W	R1464	1-247-799-00	CARBON	47 5% 1/6W
R491	1-247-839-00	CARBON	2.2K 5% 1/6W	R1465	1-247-825-00	CARBON	560 5% 1/6W
R492	1-247-829-00	CARBON	820 5% 1/6W	R1466	1-247-791-00	CARBON	22 5% 1/6W
R493	1-247-819-00	CARBON	330 5% 1/6W	R1467	1-247-839-00	CARBON	2.2K 5% 1/6W
R494	1-247-847-00	CARBON	4.7K 5% 1/6W	R1468	1-247-823-00	CARBON	470 5% 1/6W
R495	1-247-863-00	CARBON	22K 5% 1/6W	R1469	1-247-839-00	CARBON	2.2K 5% 1/6W
R496	1-247-871-00	CARBON	47K 5% 1/6W	R1470	1-247-799-00	CARBON	47 5% 1/6W
R497	1-247-855-00	CARBON	10K 5% 1/6W	R1471	1-247-825-00	CARBON	560 5% 1/6W
R499	1-247-819-00	CARBON	330 5% 1/6W	R1472	1-247-791-00	CARBON	22 5% 1/6W
R1401	1-247-839-00	CARBON	2.2K 5% 1/6W	R1473	1-247-853-00	CARBON	8.2K 5% 1/6W
R1402	1-247-831-00	CARBON	1K 5% 1/6W	R1474	1-247-851-00	CARBON	6.8K 5% 1/6W
R1403	1-247-861-00	CARBON	18K 5% 1/6W	R1475	1-247-855-00	CARBON	10K 5% 1/6W
R1404	1-247-845-00	CARBON	3.9K 5% 1/6W	R1476	1-247-815-00	CARBON	220 5% 1/6W
R1405	1-247-855-00	CARBON	10K 5% 1/6W	R1477	1-247-815-00	CARBON	220 5% 1/6W
R1406	1-247-843-00	CARBON	3.3K 5% 1/6W	R1478	1-247-815-00	CARBON	220 5% 1/6W
R1413	1-246-487-00	CARBON	3.9K 5% 1/4W	R1479	1-247-847-00	CARBON	4.7K 5% 1/6W
R1414	1-246-465-00	CARBON	470 5% 1/4W	R1480	1-247-847-00	CARBON	4.7K 5% 1/6W
R1415	1-246-491-00	CARBON	5.6K 5% 1/4W	R1481	1-247-831-00	CARBON	1K 5% 1/6W
R1417	1-247-823-00	CARBON	470 5% 1/6W	R1482	1-247-855-00	CARBON	10K 5% 1/6W
R1419	1-247-835-00	CARBON	1.5K 5% 1/6W	R1483	1-247-855-00	CARBON	10K 5% 1/6W
R1420	1-247-847-00	CARBON	4.7K 5% 1/6W	R1484	1-246-497-00	CARBON	10K 5% 1/4W
R1421	1-247-831-00	CARBON	1K 5% 1/6W	R1485	1-246-457-00	CARBON	220 5% 1/4W
R1423	1-247-827-00	CARBON	680 5% 1/6W	R1486	1-246-497-00	CARBON	10K 5% 1/4W
R1432	1-247-855-00	CARBON	10K 5% 1/6W	R1487	1-246-457-00	CARBON	220 5% 1/4W
R1433	1-247-843-00	CARBON	3.3K 5% 1/6W	R1488	1-246-497-00	CARBON	10K 5% 1/4W
R1434	1-247-848-00	CARBON	5.1K 5% 1/6W	R1489	1-246-457-00	CARBON	220 5% 1/4W
R1435	1-246-833-00	CARBON	130 5% 1/8W	R1490	1-246-497-00	CARBON	10K 5% 1/4W
R1435	1-247-833-00	CARBON	1.2K 5% 1/6W	R1492	1-246-457-00	CARBON	220 5% 1/4W
R1436	1-247-859-00	CARBON	15K 5% 1/6W				
R1437	1-247-855-00	CARBON	10K 5% 1/6W	<u>IC</u>			
R1438	1-247-849-00	CARBON	5.6K 5% 1/6W	REG401	8-759-171-05	IC UPC7805H	
R1439	1-247-847-00	CARBON	4.7K 5% 1/6W	REG402	8-759-171-12	IC UPC7812H	
R1441	1-247-863-00	CARBON	22K 5% 1/6W	<u>VARIABLE RESISTOR</u>			
R1442	1-247-901-00	CARBON	820K 5% 1/6W	RV401	1-226-853-00	RES, ADJ, CARBON 47K	
R1443	1-247-901-00	CARBON	820K 5% 1/6W	RV402	1-226-852-00	RES, ADJ, CARBON 22K	
R1444	1-247-901-00	CARBON	820K 5% 1/6W	RV403	1-226-852-00	RES, ADJ, CARBON 22K	
R1445	1-247-867-00	CARBON	33K 5% 1/6W	RV404	1-226-852-00	RES, ADJ, CARBON 22K	
R1446	1-247-867-00	CARBON	33K 5% 1/6W	RV405	1-226-852-00	RES, ADJ, CARBON 22K	
R1447	1-246-527-00	CARBON	180K 5% 1/4W	<u>SWITCH</u>			
R1448	1-247-849-00	CARBON	5.6K 5% 1/6W	S401	1-553-725-00	SWITCH, SLIDE	
R1449	1-247-839-00	CARBON	2.2K 5% 1/6W	S402	1-553-725-00	SWITCH, SLIDE	
R1451	1-247-831-00	CARBON	1K 5% 1/6W	S403	1-553-725-00	SWITCH, SLIDE	
R1452	1-247-843-00	CARBON	3.3K 5% 1/6W				
R1453	1-247-831-00	CARBON	1K 5% 1/6W				
R1454	1-247-843-00	CARBON	3.3K 5% 1/6W				
R1455	1-247-839-00	CARBON	2.2K 5% 1/6W				

C1 **C2**

Ref.No	Part No.	Description	Remark
♣:A-1330-507-A	C1 BOARD, COMPLETE	*****	
1-526-616-00	SOCKET, CRT		
<u>CAPACITOR</u>			
C701	1-123-356-00	ELECT 10MF 20%	25V
C702	1-102-002-00	CERAMIC 680PF 10%	500V
C703	1-123-356-00	ELECT 10MF 20%	25V
C704	1-102-002-00	CERAMIC 680PF 10%	500V
C705	1-123-356-00	ELECT 10MF 20%	25V
C706	1-102-002-00	CERAMIC 680PF 10%	500V
C707	1-123-356-00	ELECT 10MF 20%	25V
C708	1-121-759-00	ELECT 4.7MF	250V
C709	1-102-038-00	CERAMIC 0.001MF	500V
C710	1-108-433-00	MYLAR 0.1MF 10%	200V
C711	1-123-356-00	ELECT 10MF 20%	50V
C712	1-129-737-00	FILM 0.047MF 20%	630V
C713	1-102-249-00	CERAMIC 680PF 20%	2KV
C714	1-108-595-00	MYLAR 0.047MF 5%	50V
<u>DIODE</u>			
D701	8-719-300-76	DIODE RH-1A	
D702	8-719-300-76	DIODE RH-1A	
D703	8-719-300-76	DIODE RH-1A	
<u>COIL</u>			
L701	1-408-418-00	MICRO INDUCTOR 56UH	
L702	1-408-418-00	MICRO INDUCTOR 56UH	
L703	1-408-418-00	MICRO INDUCTOR 56UH	
L704	1-408-417-00	MICRO INDUCTOR 47UH	
L705	1-407-780-00	COIL, SPOOK CHOKE	
L706	1-408-417-00	MICRO INDUCTOR 47UH	
<u>NEON LAMP</u>			
NL701	1-519-108-XX	LAMP, NEON ASSY	
<u>TRANSISTOR</u>			
Q701	8-729-245-83	TRANSISTOR 2SC2458	
Q702	8-729-326-11	TRANSISTOR 2SC2611	
Q703	8-729-245-83	TRANSISTOR 2SC2458	
Q704	8-729-326-11	TRANSISTOR 2SC2611	
Q705	8-729-245-83	TRANSISTOR 2SC2458	
Q706	8-729-326-11	TRANSISTOR 2SC2611	
♣:4-347-706-00	HEAT SINK (TR), Q702, Q704, Q706		
<u>RESISTOR</u>			
R707	1-247-823-00	CARBON 470 5%	1/6W
R708	1-247-793-00	CARBON 27 5%	1/6W
R709	1-247-838-00	CARBON 2K 5%	1/6W
R710	1-247-815-00	CARBON 220 5%	1/6W
R711	1-247-791-00	CARBON 22 5%	1/6W

Ref.No	Part No.	Description	Remark
R712	1-206-749-00	METAL OXIDE 10K 5%	3W F
R713	1-247-823-00	CARBON 470 5%	1/6W
R714	1-247-793-00	CARBON 27 5%	1/6W
R715	1-247-838-00	CARBON 2K 5%	1/6W
R716	1-247-815-00	CARBON 220 5%	1/6W
R717	1-247-791-00	CARBON 22 5%	1/6W
R718	1-206-749-00	METAL OXIDE 10K 5%	3W F
R719	1-247-823-00	CARBON 470 5%	1/6W
R720	1-247-793-00	CARBON 27 5%	1/6W
R721	1-247-838-00	CARBON 2K 5%	1/6W
R722	1-247-815-00	CARBON 220 5%	1/6W
R723	1-247-791-00	CARBON 22 5%	1/6W
R724	1-206-749-00	METAL OXIDE 10K 5%	3W F
R725	1-202-824-00	SOLID 3.3K	1/2W
R726	1-202-824-00	SOLID 3.3K	1/2W
R727	1-202-824-00	SOLID 3.3K	1/2W
R728	1-202-549-00	SOLID 100 10%	1/2W
R729	1-202-837-00	SOLID 82K	1/2W
R730	1-202-846-00	SOLID 470K	1/2W
R731	1-202-609-00	SOLID 33K	1/2W
R732	1-202-613-00	SOLID 47K	1/2W
R733	1-202-846-00	SOLID 470K	1/2W
R734	1-202-719-00	SOLID 1M 10%	1/2W
R735	1-202-629-00	SOLID 220K	1/2W
R736	1-247-795-00	CARBON 33 5%	1/6W
R737	1-246-525-00	CARBON 150K 5%	1/4W
R738	1-247-795-00	CARBON 33 5%	1/6W
R739	1-202-844-00	SOLID 330K	1/2W
<u>VARIABLE RESISTOR</u>			
RV713	1-226-114-00	RES, ADJ, METAL GLAZE 2.2M	
RV714	1-226-063-00	RES, ADJ, CARBON 2.2M	
<u>SPARK GAP</u>			
SG701	1-519-063-XX	DISCHARGING GAP	
SG702	1-519-063-XX	DISCHARGING GAP	
SG703	1-519-063-XX	DISCHARGING GAP	
SG704	1-519-063-XX	DISCHARGING GAP	
SG705	1-519-063-XX	DISCHARGING GAP	

♣:1-612-246-11	C2 BOARD	*****	
♣:1-560-278-00	PLUG, CONNECTOR 8P		
<u>RESISTOR</u>			
R701	1-247-839-00	CARBON 2.2K 5%	1/6W
R702	1-247-823-00	CARBON 470 5%	1/6W
R703	1-247-839-00	CARBON 2.2K 5%	1/6W
R704	1-247-823-00	CARBON 470 5%	1/6W
R705	1-247-839-00	CARBON 2.2K 5%	1/6W
R706	1-247-823-00	CARBON 470 5%	1/6W



Ref.No	Part No.	Description	Remark	Ref.No	Part No.	Description	Remark
<u>VARIABLE RESISTOR</u>							
RV701	1-226-819-00	RES, ADJ, CARBON 1K		C533	1-123-335-00	ELECT 330MF 20%	25V
RV702	1-226-819-00	RES, ADJ, CARBON 1K		C534	1-123-379-00	ELECT 0.47MF 20%	50V
RV703	1-226-921-00	RES, ADJ, CARBON 4.7K		C535	1-108-429-00	MYLAR 0.047MF 10%	200V
RV704	1-226-921-00	RES, ADJ, CARBON 4.7K		C536	1-101-810-00	CERAMIC 100PF 5%	500V
RV705	1-226-819-00	RES, ADJ, CARBON 1K		C537	1-108-365-00	MYLAR 0.001MF 10%	100V
RV706	1-226-819-00	RES, ADJ, CARBON 1K		C538	▲ 1-161-961-11	CERAMIC 0.0022MF 10%	3KV
RV707	1-226-921-00	RES, ADJ, CARBON 4.7K		C539	1-108-387-00	MYLAR 0.068MF 10%	100V
RV708	1-226-921-00	RES, ADJ, CARBON 4.7K		C540	▲ 1-136-069-11	FILM 0.0044MF 3%	2KV
RV709	1-226-819-00	RES, ADJ, CARBON 1K		C541	▲ 1-129-745-51	FILM 0.033MF 10%	400V
RV710	1-226-819-00	RES, ADJ, CARBON 1K		C542	1-102-223-00	CERAMIC 0.0047MF 10%	2KV
RV711	1-226-921-00	RES, ADJ, CARBON 4.7K		C543	1-123-254-00	ELECT 10MF	250V
RV712	1-226-921-00	RES, ADJ, CARBON 4.7K		C544	1-102-038-00	CERAMIC 0.001MF	500V
<u>SWITCH</u>							
S701	1-516-503-00	SLIDE SWITCH		C545	1-123-333-00	ELECT 100MF 20%	25V

▲:A-1345-456-A D BOARD, COMPLETE							

▲:4-367-226-00 HOLDER, H OUT							
<u>CAPACITOR</u>							
C501	1-123-381-00	ELECT 2.2MF	20% 50V	C553	1-108-377-00	MYLAR 0.01MF	10% 100V
C502	1-123-369-00	ELECT 4.7MF	20% 50V	C554	1-123-333-00	ELECT 100MF	20% 25V
C503	1-108-555-00	MYLAR 0.001MF	5% 50V	C555	1-102-228-00	CERAMIC 470PF	10% 500V
C504	1-108-559-00	MYLAR 0.0015MF	5% 50V	C556	1-123-360-00	ELECT 100MF	20% 50V
C505	1-102-115-00	CERAMIC 560PF	10% 50V	C557	1-106-204-00	MYLAR 0.022MF	10% 100V
C507	1-108-384-00	MYLAR 0.039MF	10% 100V	C559	1-123-330-00	ELECT 22MF	20% 16V
C508	1-123-380-00	ELECT 1MF	50V	C560	1-108-383-00	MYLAR 0.033MF	10% 100V
C509	1-108-377-00	MYLAR 0.01MF	10% 100V	C561	1-123-356-00	ELECT 10MF	20% 16V
C510	1-123-382-00	ELECT 3.3MF	20% 50V	C562	1-123-332-00	ELECT 47MF	20% 16V
C511	1-123-379-00	ELECT 0.47MF	20% 50V	C563	1-123-332-00	ELECT 47MF	20% 16V
C513	1-130-640-00	FILM 0.47MF	5% 50V	C564	▲ 1-136-068-11	FILM 0.004MF	3% 2KV
C514	1-131-369-00	TANTALUM 4.7MF	20% 16V	C565	▲ 1-136-068-11	FILM 0.004MF	3% 2KV
C515	1-123-356-00	ELECT 10MF	20% 25V	C566	1-101-006-00	CERAMIC 0.047MF	50V
C516	1-106-204-00	MYLAR 0.022MF	10% 100V	C567	1-101-006-00	CERAMIC 0.047MF	50V
C517	1-108-595-00	MYLAR 0.047MF	5% 50V	C568	1-123-321-00	ELECT 220MF	20% 16V
C518	1-123-321-00	ELECT 220MF	20% 16V	C569	1-108-377-00	MYLAR 0.01MF	10% 100V
C519	1-102-989-00	CERAMIC 68PF	5% 500V	C570	1-108-377-00	MYLAR 0.01MF	10% 100V
C520	1-106-204-00	MYLAR 0.022MF	10% 100V	C571	1-101-006-00	CERAMIC 0.047MF	50V
C521	1-108-377-00	MYLAR 0.01MF	10% 100V	C572	1-101-006-00	CERAMIC 0.047MF	50V
C523	1-106-204-00	MYLAR 0.022MF	10% 100V	C573	1-108-816-00	FILM 0.1MF	50V
C524	1-106-180-00	MYLAR 0.0022MF	5% 100V	C575	1-123-024-00	ELECT 33MF	160V
C525	1-129-794-00	FILM 0.0033MF	5% 100V	C801	1-123-369-00	ELECT 4.7MF	20% 50V
C526	1-123-381-00	ELECT 2.2MF	20% 50V	C802	1-123-369-00	ELECT 4.7MF	20% 50V
C527	1-123-381-00	ELECT 2.2MF	20% 50V	C803	1-108-591-00	MYLAR 0.033MF	5% 50V
C528	1-101-006-00	CERAMIC 0.047MF	50V	C803	1-123-333-00	ELECT 100MF	20% 25V
C529	1-123-230-00	ELECT 2.2MF	20% 50V	C804	1-124-192-00	ELECT 4.7MF	20% 50V
C530	1-123-379-00	ELECT 0.47MF	20% 50V	C805	1-108-372-00	MYLAR 0.0039MF	10% 100V
C531	1-123-381-00	ELECT 2.2MF	20% 50V	C806	1-123-380-00	ELECT 1MF	20% 50V
				C807	1-123-332-00	ELECT 47MF	20% 16V
				C808	1-123-228-00	ELECT 1MF	20% 50V
				C810	1-123-336-00	ELECT 470MF	20% 25V
				C813	1-108-433-00	MYLAR 0.1MF	10% 200V

The components identified by shading and mark ▲ are critical for safety. Replace only with part number specified.

Les composants identifiés par une trame et une marque ▲ sont critiques pour la sécurité. Ne les remplacer que par une pièce portant le numéro spécifié.



Ref.No	Part No.	Description	Remark	Ref.No	Part No.	Description	Remark
<u>CONNECTOR</u>				<u>TRANSISTOR</u>			
D1	▲:1-560-126-00	PLUG, CONNECTOR (2.5MM) 6P		L802	1-459-338-00	COIL, VAR, FERRITE (PAC)	
D2	▲:1-560-126-00	PLUG, CONNECTOR (2.5MM) 6P		<u>TRANSISTOR</u>			
D3	▲:1-560-126-00	PLUG, CONNECTOR (2.5MM) 6P		Q501	8-729-384-48	TRANSISTOR 2SA844	
D4	▲:1-560-126-00	PLUG, CONNECTOR (2.5MM) 6P		Q502	8-729-245-83	TRANSISTOR 2SC2458	
D5	▲:1-508-767-00	5P PLUG		Q508	8-729-168-82	TRANSISTOR 2SC2688	
D6	▲:1-564-038-00	CONNECTOR PLUG, DY (MINI) 6P		Q509	8-729-800-87	TRANSISTOR 2SD1398-CA	
D7	▲:1-560-124-00	PLUG, CONNECTOR (2.5MM) 4P		Q510	8-729-245-83	TRANSISTOR 2SC2458	
D8	▲:1-560-124-00	PLUG, CONNECTOR (2.5MM) 4P		Q511	8-729-900-63	TRANSISTOR DTA124ES	
<u>DIODE</u>				Q512	8-729-177-43	TRANSISTOR 2SD774	
D502	8-719-911-19	DIODE 1SS119		Q801	8-729-313-42	TRANSISTOR 2SD1134	
D505	8-719-911-19	DIODE 1SS119		Q802	8-729-245-83	TRANSISTOR 2SC2458	
D506	8-719-911-19	DIODE 1SS119		Q851	8-729-384-48	TRANSISTOR 2SA844	
D507	8-719-102-67	DIODE RD5.1E-N1		<u>RESISTOR</u>			
D508	8-719-911-19	DIODE 1SS119		R501	1-247-835-00	CARBON	1.5K 5% 1/6W
D509	8-719-305-15	DIODE GH-3F		R502	1-244-865-00	CARBON	470 1/2W
D510	8-719-928-08	DIODE ERD28-08S		R503	1-247-823-00	CARBON	470 5% 1/6W
D511	8-719-903-09	DIODE V30N		R504	1-247-831-00	CARBON	1K 5% 1/6W
D512	8-719-901-93	DIODE V19E		R505	1-247-855-00	CARBON	10K 5% 1/6W
D513	8-719-901-93	DIODE V19E		R506	1-247-839-00	CARBON	2.2K 5% 1/6W
D514	8-719-911-55	DIODE U05G		R508	1-247-835-00	CARBON	1.5K 5% 1/6W
D515	8-719-901-93	DIODE V19E		R509	1-247-839-00	CARBON	2.2K 5% 1/6W
D516	8-719-911-19	DIODE 1SS119		R510	1-247-865-00	CARBON	27K 5% 1/6W
D517	8-719-911-55	DIODE U05G		R511	1-215-459-00	METAL	39K 1% 1/6W
D518	8-719-911-55	DIODE U05G		R514	1-215-475-00	METAL	180K 1% 1/6W
D519	8-719-911-55	DIODE U05G		R515	1-215-463-00	METAL	56K 1% 1/6W
D520	8-719-911-19	DIODE 1SS119		R519	1-215-463-00	METAL	56K 1% 1/6W
D521	8-719-911-19	DIODE 1SS119		R520	1-247-819-00	CARBON	330 5% 1/6W
D523	8-719-000-24	THYRISTOR CRO2AM-4		R521	1-247-827-00	CARBON	680 5% 1/6W
D524	8-719-911-19	DIODE 1SS119		R522	1-247-827-00	CARBON	680 5% 1/6W
D525	8-719-102-84	DIODE RD8.2E-N2		R523	1-247-823-00	CARBON	470 5% 1/6W
D803	8-719-936-19	DIODE EQA01-19R		R524	1-247-849-00	CARBON	5.6K 5% 1/6W
D804	8-719-931-22	DIODE EQB01-22		R526	1-247-851-00	CARBON	6.8K 5% 1/6W
<u>IC</u>				R527	1-247-857-00	CARBON	12K 5% 1/6W
IC501	8-759-100-60	IC UPC1377C		R528	1-247-847-00	CARBON	4.7K 5% 1/6W
IC503	8-759-145-58	IC UPC4558C		R530	1-215-459-00	METAL	39K 1% 1/6W
IC504	8-759-145-58	IC UPC4558C		R531	1-247-835-00	CARBON	1.5K 5% 1/6W
IC505	8-759-113-78	IC UPC1378H-L		R532	1-246-992-00	CARBON	180 5% 1/8W F
IC801	8-759-905-39	IC TDA1082		R533	1-247-851-00	CARBON	6.8K 5% 1/8W
<u>COIL</u>				R534	1-247-835-00	CARBON	1.5K 5% 1/6W
L501	1-408-242-00	MICRO INDUCTOR 10MMH		R535	1-215-456-00	METAL	30K 1% 1/6W
L502	1-407-780-00	COIL, SPOOK CHOKE		R536	1-247-857-00	CARBON	12K 5% 1/6W
L503	1-407-365-00	COIL, CHOKE		R537	1-247-879-00	CARBON	100K 5% 1/6W
L504	1-459-390-00	COIL (WITH CORE)		R538	1-247-847-00	CARBON	4.7K 5% 1/6W
L505	▲1-421-368-11	COIL, VAR FERRITE (HLC)		R540	1-247-859-00	CARBON	15K 5% 1/6W
L506	1-408-239-00	MICRO INDUCTOR 4.7MMH		R541	1-215-477-00	METAL	220K 1% 1/6W
L507	1-459-104-00	COIL, DUST CORE		R542	1-215-447-00	METAL	12K 1% 1/6W
L508	1-408-242-00	MICRO INDUCTOR 10MMH		R543	1-247-849-00	CARBON	5.6K 5% 1/6W
L509	▲1-421-329-31	COIL, CHOKE		R544	1-247-849-00	CARBON	5.6K 5% 1/6W
L801	1-459-075-00	COIL, DYNAMIC CONVERSION CHOKE		R545	1-247-841-00	CARBON	2.7K 5% 1/6W
				R546	1-215-447-00	METAL	12K 1% 1/6W
				R547	1-215-477-00	METAL	220K 1% 1/6W
				R548	1-247-813-00	CARBON	180 5% 1/6W

The components identified by shading and mark ▲ are critical for safety. Replace only with part number specified.

• The components identified by ☒ in this manual have been carefully factory-selected for each set in order to satisfy regulations regarding X-ray radiation. Should replacement be required, replace only with the value originally used.

Les composants identifiés par une trame et une marque ▲ sont critiques pour la sécurité. Ne les remplacer que par une pièce portant le numéro spécifié.



Ref.No	Part No.	Description				Remark	Ref.No	Part No.	Description				Remark
R549	1-211-449-00	CARBON	820	5%	1/8W	F	R807	1-247-861-00	CARBON	18K	5%	1/6W	
R550	1-247-855-00	CARBON	10K	5%	1/6W		R809	1-247-867-00	CARBON	33K	5%	1/6W	
R551	1-247-809-00	CARBON	120	5%	1/6W		R810	1-247-845-00	CARBON	3.9K	5%	1/6W	
R552	1-247-855-00	CARBON	10K	5%	1/6W		R811	1-247-867-00	CARBON	33K	5%	1/6W	
R553	1-205-642-00	CEMENTED	3.3K	10%	5W		R812	1-247-863-00	CARBON	22K	5%	1/6W	
R554	1-247-837-00	CARBON	1.8K	5%	1/8W	F	R813	1-247-845-00	CARBON	3.9K	5%	1/6W	
R555	1-247-831-00	CARBON	1K	5%	1/6W		R814	1-247-869-00	CARBON	39K	5%	1/6W	
R556	1-247-636-00	CARBON	0.47	5%	1/8W	F	R815	1-247-865-00	CARBON	27K	5%	1/6W	
R557	1-247-636-00	CARBON	0.47	5%	1/8W	F	R816	1-247-831-00	CARBON	1K	5%	1/6W	
R558	1-217-407-00	FUSIBLE	470		1/4W	F	R817	1-247-831-00	CARBON	1K	5%	1/6W	
R559	1-210-859-00	CARBON	1.2	5%	1/8W	F	R818	1-247-891-00	CARBON	330K	5%	1/6W	
R560	1-202-597-00	SOLID	10K	10%	1/2W		R825	1-212-363-00	METAL OXIDE	1.8	5%	1W	F
R563	1-213-141-00	METAL OXIDE	680	5%	1W	F	R827	1-247-859-00	CARBON	15K	5%	1/6W	
R564	1-213-129-00	METAL OXIDE	68	5%	1W	F	R840	1-247-855-00	CARBON	10K	5%	1/6W	
R565	1-212-371-00	METAL OXIDE	8.2	5%	1W	F	R841	1-244-883-00	CARBON	2.7K	5%	1/2W	
R566	1-247-889-00	CARBON	270K	5%	1/6W		R842	1-246-475-00	CARBON	1.2K	5%	1/4W	
R567	1-247-903-00	CARBON	1M	5%	1/6W		R843	1-246-501-00	CARBON	15K	5%	1/4W	
R568	1-213-137-00	METAL OXIDE	330	5%	1W	F	R844	1-246-501-00	CARBON	15K	5%	1/4W	
R569	1-213-137-00	METAL OXIDE	330	5%	1W	F	R850	1-247-831-00	CARBON	1k	5%	1/6W	
R570	1-247-230-00	CARBON	390	5%	1/2W		R851	1-247-807-00	CARBON	100	5%	1/6W	
R571	1-247-863-00	CARBON	22K	5%	1/6W		R852	1-247-807-00	CARBON	100	5%	1/6W	
R572	1-247-865-00	CARBON	27K	5%	1/6W				VARIABLE RESISTOR				
R573	1-247-843-00	CARBON	3.3K	5%	1/6W		RV501	1-228-577-00	RES, ADJ, CARBON	220			
R574	1-247-871-00	CARBON	47K	5%	1/6W		RV502	1-226-850-00	RES, ADJ, CARBON	4.7K			
R575	1-247-879-00	CARBON	100K	5%	1/6W		RV503	1-226-851-00	RES, ADJ, CARBON	10K			
R576	1-247-855-00	CARBON	10K	5%	1/6W		RV504	1-228-160-11	RES, ADJ, METAL GLAZE	5K			
R577	1-247-855-00	CARBON	10K	5%	1/6W		RV505	1-222-344-00	RES, ADJ, CARBON	5K			
R578	1-247-869-00	CARBON	39K	5%	1/6W		RV506	1-223-102-00	RES, ADJ, WIREWOUND	120			
R579	1-215-475-00	METAL	180K	1%	1/6W		RV507	1-226-854-00	RES, ADJ, CARBON	100K			
R580	1-246-483-00	CARBON	2.7K	5%	1/4W		RV509	1-224-249-XX	RES, ADJ, METAL GLAZE	1K			
R581	1-246-483-00	CARBON	2.7K	5%	1/4W		RV801	1-226-851-00	RES, ADJ, CARBON	10K			
R582	1-247-833-00	CARBON	1.2K	5%	1/6W		RV802	1-226-847-00	RES, ADJ, CARBON	1K			
R583	1-247-831-00	CARBON	1K	5%	1/6W		RV803	1-226-847-00	RES, ADJ, CARBON	1K			
R584	1-247-875-00	CARBON	68K	5%	1/6W				SPARK GAP				
R585	1-247-875-00	CARBON	68K	5%	1/6W		SG501	1-519-063-XX	DISCHARGING GAP				
R586	1-215-493-00	METAL	1M	1%	1/6W				TRANSFORMER				
R587	1-247-855-00	CARBON	10K	5%	1/6W		T501	1-437-078-00	TRANSFORMER, HORIZONTAL DRIVE				
R588	1-247-877-00	CARBON	82K	5%	1/6W		T503	1-421-520-00	TRANSFORMER, FERRITE (PHT)				
R589	1-247-877-00	CARBON	82K	5%	1/6W		T801	1-421-245-11	TRANSFORMER, PZN CUSHION				
R590	1-247-852-00	CARBON	7.5K	5%	1/6W				*****				
R591	1-247-825-00	CARBON	560	5%	1/6W				●:1-612-248-11 H BOARD				
R592	1-247-831-00	CARBON	1K	5%	1/6W				*****				
R593	1-247-837-00	CARBON	1.8K	5%	1/6W				●:4-370-916-01 HOLDER (5 GANG), LED				
R595	1-247-855-00	CARBON	10K	5%	1/6W				DIODE				
R596	1-212-373-00	METAL OXIDE	12	5%	1W	F	D301	8-719-114-34	DIODE SY432D				
R597	1-215-373-31	METAL	10	1%	1/6W		D302	8-719-114-34	DIODE SY432D				
R598	1-247-855-00	CARBON	10K	5%	1/6W		D303	8-719-114-34	DIODE SY432D				
R599	1-247-865-00	CARBON	27K	5%	1/6W		D304	8-719-114-34	DIODE SY432D				
R801	1-247-857-00	CARBON	12K	5%	1/6W		D305	8-719-114-34	DIODE SY432D				
R802	1-247-863-00	CARBON	22K	5%	1/6W								
R803	1-211-431-00	CARBON	150	5%	1/8W	F							
R805	1-247-815-00	CARBON	220	5%	1/6W								
R806	1-247-875-00	CARBON	68K	5%	1/6W								

PVM-1910/1911



Ref.No	Part No.	Description	Remark	Ref.No	Part No.	Description	Remark
<u>RESISTOR</u>				<u>CAPACITOR</u>			
R301	1-247-846-00	CARBON 4.3K 5% 1/6W		C004	1-123-356-00	ELECT 10MF 20% 25V	
R302	1-247-868-00	CARBON 36K 5% 1/6W		C005	1-123-356-00	ELECT 10MF 20% 25V	
R303	1-247-852-00	CARBON 7.5K 5% 1/6W		C006	1-123-356-00	ELECT 10MF 20% 25V	
R305	1-247-831-00	CARBON 1K 5% 1/6W		C007	1-123-356-00	ELECT 10MF 20% 25V	
R306	1-247-831-00	CARBON 1K 5% 1/6W		C008	1-123-380-00	ELECT 1MF 20% 50V	
R307	1-247-831-00	CARBON 1K 5% 1/6W		C009	1-106-212-00	MYLAR 0.047MF 10% 100V	
R309	1-247-835-00	CARBON 1.5K 5% 1/6W		C010	1-123-356-00	ELECT 10MF 20% 25V	
<u>VARIABLE RESISTOR</u>				C011	1-123-356-00	ELECT 10MF 20% 25V	
RV301	1-228-938-00	RES, VAR, CARBON 20K		C012	1-123-356-00	ELECT 10MF 20% 25V	
RV302	1-228-936-00	RES, VAR, CARBON 10K		C013	1-123-356-00	ELECT 10MF 20% 25V	
RV303	1-228-938-00	RES, VAR, CARBON 20K		C014	1-123-380-00	ELECT 1MF 20% 50V	
RV304	1-228-938-00	RES, VAR, CARBON 20K		C015	1-106-212-00	MYLAR 0.047MF 10% 100V	
RV305	1-228-937-00	RES, VAR, CARBON 20K		C017	1-106-212-00	MYLAR 0.047MF 10% 100V	
RV306	1-228-937-00	RES, VAR, CARBON 20K		C018	1-123-380-00	ELECT 1MF 20% 50V	
RV307	1-228-938-00	RES, VAR, CARBON 20K		C019	1-123-356-00	ELECT 10MF 20% 25V	
<u>SWITCH</u>				C020	1-123-356-00	ELECT 10MF 20% 25V	
S301	1-554-405-00	SWITCH, PUSH (5 KEY)		C021	1-123-356-00	ELECT 10MF 20% 25V	
S302	1-554-118-00	SWITCH, PUSH		C022	1-123-356-00	ELECT 10MF 20% 25V	
S303	1-554-118-00	SWITCH, PUSH		C023	1-123-356-00	ELECT 10MF 20% 25V	
S304	1-554-118-00	SWITCH, PUSH		C024	1-123-356-00	ELECT 10MF 20% 25V	
*****				C025	1-123-356-00	ELECT 10MF 20% 25V	
♣:1-612-249-11	X BOARD	*****		C026	1-123-332-00	ELECT 47MF 20% 25V	
♣:4-345-701-00	HOLDER, LED			C027	1-123-356-00	ELECT 10MF 20% 25V	
<u>DIODE</u>				C100	1-102-971-00	CERAMIC 82PF 5% 50V	
D311	8-719-102-34	DIODE SG232D		C101	1-123-332-00	ELECT 47MF 20% 16V	
*****				C102	1-123-356-00	ELECT 10MF 20% 25V	
♣:A-1135-240-A	B BOARD, COMPLETE (PVM-1910)			C104	1-102-973-00	CERAMIC 100PF 5% 50V	
♣:A-1135-244-A	B BOARD, COMPLETE (PVM-1911)	*****		C105	1-123-356-00	ELECT 10MF 20% 16V	
♣:4-323-833-00	HEAT SINK, PIN OUT			C106	1-123-356-00	ELECT 10MF 20% 25V	
<u>CONNECTOR</u>				C107	1-102-978-00	CERAMIC 220PF 5% 50V	
B1	♣:1-560-124-00	PLUG, CONNECTOR (2.5MM) 4P		C108	1-123-356-00	ELECT 10MF 20% 16V	
B2	♣:1-560-224-00	PLUG, CONNECTOR (2.5MM) 10P		C109	1-102-959-00	CERAMIC 22PF 5% 50V	
B3	♣:1-560-124-00	PLUG, CONNECTOR (2.5MM) 4P		C110	1-102-961-00	CERAMIC 27PF 5% 50V	
B4	♣:1-560-125-00	PLUG, CONNECTOR (2.5MM) 5P		C111	1-101-888-00	CERAMIC 68PF 5% 50V	
B5	♣:1-560-156-00	PLUG, CONNECTOR (2.5MM PITCH)		C112	1-102-971-00	CERAMIC 82PF 5% 50V	
B6	♣:1-560-290-00	PLUG, CONNECTOR (2.5MM PITCH)		C113	1-102-978-00	CERAMIC 220PF 5% 50V	
B7	♣:1-560-125-00	PLUG, CONNECTOR (2.5MM) 5P		C114	1-123-332-00	ELECT 47MF 20% 16V	
B8	♣:1-560-124-00	PLUG, CONNECTOR (2.5MM) 4P		C115	1-123-356-00	ELECT 10MF 20% 16V	
B9	♣:1-560-290-00	PLUG, CONNECTOR (2.5MM) (PVM-1911 ONLY)		C117	1-123-356-00	ELECT 10MF 20% 25V	
				C121	1-102-944-00	CERAMIC 7PF 0.5PF 50V	
				C122	1-102-944-00	CERAMIC 7PF 0.5PF 50V	
				C123	1-123-380-00	ELECT 1MF 20% 50V	
				C124	1-123-356-00	ELECT 10MF 20% 25V	
				C127	1-101-004-00	CERAMIC 0.01MF 50V	
				C128	1-123-380-00	ELECT 1MF 20% 50V	
				C129	1-123-379-00	ELECT 0.47MF 20% 50V	
				C130	1-123-380-00	ELECT 1MF 20% 50V	
				C131	1-108-389-00	MYLAR 0.1MF 10% 100V	
				C133	1-123-332-00	ELECT 47MF 16V	
				C134	1-102-944-00	CERAMIC 7PF 0.5PF 50V	
				C135	1-102-978-00	CERAMIC 220PF 5% 50V	

Ref.No	Part No.	Description	Remark	Ref.No	Part No.	Description	Remark
C136	1-101-888-00	CERAMIC	68PF	5%	50V		
C138	1-101-004-00	CERAMIC	0.01MF		50V		
C140	1-123-381-00	ELECT	2.2MF	20%	50V		
C141	1-101-006-00	CERAMIC	0.047MF		50V		
C142	1-101-006-00	CERAMIC	0.047MF		50V		
C143	1-101-880-00	CERAMIC	47PF	5%	50V		
C144	1-101-880-00	CERAMIC	47PF	5%	50V		
C145	1-102-934-00	CERAMIC	1PF	0.25PF	50V		
C146	1-102-963-00	CERAMIC	33PF	5%	50V		
C148	1-123-356-00	ELECT	10MF	20%	25V		
C149	1-161-330-00	CERAMIC	0.01MF	30%	25V		
C155	1-102-946-00	CERAMIC	9PF	0.5PF	50V		
C157	1-123-380-00	ELECT	1MF	20%	50V		
C158	1-123-382-00	ELECT	3.3MF	20%	50V		
C159	1-124-049-00	ELECT	0.47MF	20%	50V		
C161	1-102-971-00	CERAMIC	82PF	5%	50V		
C162	1-101-361-00	CERAMIC	150PF	5%	50V		
C163	1-102-971-00	CERAMIC	82PF	5%	50V		
C164	1-121-257-00	ELECT	4.7MF		16V		
C165	1-101-361-00	CERAMIC	150PF	5%	50V		
C167	1-101-006-00	CERAMIC	0.047MF		50V		
C169	1-108-389-00	MYLAR	0.1MF	10%	100V		
C170	1-123-380-00	ELECT	1MF	20%	50V		
C173	1-123-607-00	ELECT	0.1MF	20%	50V		
C175	1-101-361-00	CERAMIC	150PF	5%	50V		
C178	1-123-356-00	ELECT	10MF	20%	25V		
C180	1-123-323-00	ELECT	470MF	20%	16V		
C182	1-101-004-00	CERAMIC	0.01MF		50V		
C183	1-123-356-00	ELECT	10MF	20%	25V		
C184	1-123-356-00	ELECT	10MF	20%	25V		
C186	1-123-356-00	ELECT	10MF	20%	25V		
C187	1-101-004-00	CERAMIC	0.01MF		50V		
C188	1-123-356-00	ELECT	10MF	20%	25V		
C189	1-123-356-00	ELECT	10MF	20%	25V		
C190	1-123-356-00	ELECT	10MF	20%	25V		
C191	1-101-004-00	CERAMIC	0.01MF		50V		
C200	1-123-607-00	ELECT	0.1MF	20%	50V		
C201	1-123-607-00	ELECT	0.1MF	20%	50V		
C202	1-123-607-00	ELECT	0.1MF	20%	50V		
C203	1-121-257-00	ELECT	4.7MF		16V		
C204	1-123-381-00	ELECT	2.2MF	20%	50V		
C208	1-101-880-00	CERAMIC	47PF	5%	50V		
C209	1-102-971-00	CERAMIC	82PF	5%	50V		
C210	1-101-361-00	CERAMIC	150PF	5%	50V		
C211	1-108-377-00	MYLAR	0.01MF	10%	100V		
C213	1-101-004-00	CERAMIC	0.01MF		50V		
C214	1-108-579-00	MYLAR	0.01MF	5%	50V		
C216	1-102-824-00	CERAMIC	470PF	5%	50V		
C217	1-123-356-00	ELECT	10MF	20%	25V		
C220	1-123-325-00	ELECT	2200MF	20%	16V		
C221	1-108-389-00	MYLAR	0.1MF	10%	100V		
C222	1-123-321-00	ELECT	220MF	20%	16V		
C223	1-123-332-00	ELECT	47MF	20%	16V		
C224	1-123-369-00	ELECT	4.7MF	20%	25V		
C225	1-123-380-00	ELECT	1MF	20%	50V		
C226	1-102-125-00	CERAMIC	0.0047MF	10%	50V		
C227	1-123-379-00	ELECT	0.47MF	20%	50V		
C228	1-123-332-00	ELECT	47MF	20%	25V		
C229	1-123-369-00	ELECT	4.7MF	20%	25V		
C230	1-102-824-00	CERAMIC	470PF	5%	50V		
C231	1-123-356-00	ELECT	10MF	20%	16V		
C232	1-123-356-00	ELECT	10MF	20%	16V		
C233	1-123-379-00	ELECT	0.47MF	20%	50V		
C234	1-108-377-00	MYLAR	0.01MF	10%	100V		
C235	1-123-321-00	ELECT	220MF	20%	16V		
C238	1-123-332-00	ELECT	47MF	20%	16V		
C239	1-101-004-00	CERAMIC	0.01MF		50V		
C240	1-102-959-00	CERAMIC	22PF	5%	50V		
C241	1-102-959-00	CERAMIC	22PF	5%	50V		
C242	1-123-356-00	ELECT	10MF	20%	25V		
C243	1-101-004-00	CERAMIC	0.01MF		50V		
C244	1-101-004-00	CERAMIC	0.01MF		50V		
C343	1-101-004-00	CERAMIC	0.01MF		50V		
<u>DIODE</u>							
D001	8-719-911-19	DIODE	ISS119				
D002	8-719-911-19	DIODE	ISS119				
D003	8-719-911-19	DIODE	ISS119				
D004	8-719-911-19	DIODE	ISS119				
D005	8-719-911-19	DIODE	ISS119				
D007	8-719-911-19	DIODE	ISS119				
D108	8-719-911-19	DIODE	ISS119				
D115	8-719-911-19	DIODE	ISS119				
D116	8-719-911-19	DIODE	ISS119				
D117	8-719-911-19	DIODE	ISS119				
D118	8-719-911-19	DIODE	ISS119				
D119	8-719-911-19	DIODE	ISS119				
D120	8-719-911-19	DIODE	ISS119				
D121	8-719-911-19	DIODE	ISS119				
D122	8-719-911-19	DIODE	ISS119				
D123	8-719-911-19	DIODE	ISS119				
D124	8-719-100-37	DIODE	RD6.2E-B1				
<u>DELAY LINE</u>							
DL101	1-415-207-21	DELAY LINE (1H)					
DL102	1-415-188-00	DELAY LINE					
<u>FUSE</u>							
F201	A.1-532-624-11	FUSE, GLASS TUBE					

The components identified by shading and mark  are critical for safety. Replace only with part number specified.

Les composants identifiés par une trame et une marque  sont critiques pour la sécurité. Ne les remplacer que par une pièce portant le numéro spécifié.

PVM-1910/1911

B

Ref.No	Part No.	Description	Remark	Ref.No	Part No.	Description	Remark
<u>IC</u>							
IC001	8-759-700-06	IC UPC7812H		Q113	8-729-245-83	TRANSISTOR 2SC2458	
IC101	8-752-006-10	IC CX20061		Q116	8-729-204-83	TRANSISTOR 2SA1048-GR	
IC102	8-752-006-10	IC CX20061		Q124	8-769-200-30	TRANSISTOR 2SK107-3	
IC103	8-759-113-65	IC UPC1365C		Q138	8-729-204-83	TRANSISTOR 2SA1048-GR	
IC201	8-759-100-15	IC UPC1364C2		Q145	8-729-245-83	TRANSISTOR 2SC2458	
IC202	8-759-101-77	IC UPC1241H		Q148	8-729-245-83	TRANSISTOR 2SC2458	
IC203	8-759-610-95	IC CX095E		Q149	8-729-204-83	TRANSISTOR 2SA1048-GR	
<u>CONNECTOR</u>							
J1	1-562-121-00	CONNECTOR, DIN 6P		Q151	8-729-245-83	TRANSISTOR 2SC2458	
J2	1-536-842-11	TERMINAL BOARD, INPUT/OUTPUT (A)		Q153	8-729-245-83	TRANSISTOR 2SC2458	
<u>COIL</u>							
L101	1-408-412-00	MICRO INDUCTOR 18UH		Q155	8-729-245-83	TRANSISTOR 2SC2458	
L102	1-408-412-00	MICRO INDUCTOR 18UH		Q156	8-729-245-83	TRANSISTOR 2SC2458	
L103	1-408-411-00	MICRO INDUCTOR 15UH		Q157	8-729-245-83	TRANSISTOR 2SC2458	
L104	1-408-414-00	MICRO INDUCTOR 27UH		Q158	8-769-200-30	TRANSISTOR 2SK107-3	
L105	1-408-414-00	MICRO INDUCTOR 27UH		Q159	8-729-204-83	TRANSISTOR 2SA1048-GR	
L106	1-408-409-00	MICRO INDUCTOR 10UH		<u>RESISTOR</u>			
L108	1-408-416-00	MICRO INDUCTOR 39UH		R002	1-247-831-00	CARBON 1K 5%	1/6W
L110	1-408-412-00	MICRO INDUCTOR 18UH		R003	1-247-865-00	CARBON 27K 5%	1/6W
L111	1-408-406-00	MICRO INDUCTOR 5.6UH		R004	1-247-845-00	CARBON 3.9K 5%	1/6W
L201	1-408-245-00	MICRO INDUCTOR 22MMH		R005	1-247-839-00	CARBON 2.2K 5%	1/6W
L202	1-408-163-00	MICRO INDUCTOR 5.6MMH		R006	1-247-875-00	CARBON 68K 5%	1/6W
L203	1-408-414-00	MICRO INDUCTOR 27UH		R007	1-247-863-00	CARBON 22K 5%	1/6W
L204	1-408-421-00	MICRO INDUCTOR 100UH		R009	1-247-850-00	CARBON 6.2K 5%	1/6W
<u>TRANSISTOR</u>				R010	1-247-850-00	CARBON 6.2K 5%	1/6W
Q001	8-729-245-83	TRANSISTOR 2SC2458		R011	1-247-850-00	CARBON 6.2K 5%	1/6W
Q002	8-729-204-83	TRANSISTOR 2SA1048-GR		R012	1-247-871-00	CARBON 47K 5%	1/6W
Q003	8-729-204-83	TRANSISTOR 2SA1048-GR		R013	1-247-877-00	CARBON 82K 5%	1/6W
Q004	8-729-204-83	TRANSISTOR 2SA1048-GR		R014	1-247-885-00	CARBON 180K 5%	1/6W
Q005	8-729-245-83	TRANSISTOR 2SC2458		R015	1-247-873-00	CARBON 56K 5%	1/6W
Q006	8-729-204-83	TRANSISTOR 2SA1048-GR		R016	1-247-831-00	CARBON 1K 5%	1/6W
Q007	8-729-204-83	TRANSISTOR 2SA1048-GR		R017	1-247-804-00	CARBON 75 5%	1/6W
Q008	8-729-245-83	TRANSISTOR 2SC2458		R019	1-247-804-00	CARBON 75 5%	1/6W
Q009	8-729-204-83	TRANSISTOR 2SA1048-GR		R020	1-247-865-00	CARBON 27K 5%	1/6W
Q010	8-729-245-83	TRANSISTOR 2SC2458		R021	1-247-845-00	CARBON 3.9K 5%	1/6W
Q011	8-729-245-83	TRANSISTOR 2SC2458		R022	1-247-863-00	CARBON 22K 5%	1/6W
Q012	8-729-204-83	TRANSISTOR 2SA1048-GR		R023	1-247-875-00	CARBON 68K 5%	1/6W
Q101	8-729-245-83	TRANSISTOR 2SC2458		R024	1-247-850-00	CARBON 6.2K 5%	1/6W
Q102	8-729-245-83	TRANSISTOR 2SC2458		R025	1-247-871-00	CARBON 47K 5%	1/6W
Q103	8-729-245-83	TRANSISTOR 2SC2458		R026	1-247-873-00	CARBON 56K 5%	1/6W
Q104	8-729-245-83	TRANSISTOR 2SC2458		R027	1-247-877-00	CARBON 82K 5%	1/6W
Q105	8-729-245-83	TRANSISTOR 2SC2458		R028	1-247-885-00	CARBON 180K 5%	1/6W
Q106	8-729-245-83	TRANSISTOR 2SC2458		R029	1-247-855-00	CARBON 10K 5%	1/6W
Q107	8-729-245-83	TRANSISTOR 2SC2458		R030	1-247-885-00	CARBON 180K 5%	1/6W
Q108	8-729-245-83	TRANSISTOR 2SC2458		R031	1-247-877-00	CARBON 82K 5%	1/6W
Q109	8-729-204-83	TRANSISTOR 2SA1048-GR		R032	1-247-871-00	CARBON 47K 5%	1/6W
Q110	8-729-245-83	TRANSISTOR 2SC2458		R033	1-247-863-00	CARBON 22K 5%	1/6W
Q111	8-729-245-83	TRANSISTOR 2SC2458		R034	1-247-875-00	CARBON 68K 5%	1/6W
				R035	1-247-831-00	CARBON 1K 5%	1/6W
				R036	1-247-804-00	CARBON 75 5%	1/6W
				R037	1-247-865-00	CARBON 27K 5%	1/6W
				R038	1-247-845-00	CARBON 3.9K 5%	1/6W
				R039	1-247-850-00	CARBON 6.2K 5%	1/6W
				R040	1-247-875-00	CARBON 68K 5%	1/6W

B

Ref.No	Part No.	Description	Remark	Ref.No	Part No.	Description	Remark
R041	1-247-804-00	CARBON	75 5% 1/6W	R145	1-247-863-00	CARBON	22K 5% 1/6W
R042	1-247-865-00	CARBON	27K 5% 1/6W	R147	1-247-835-00	CARBON	1.5K 5% 1/6W
R043	1-247-878-00	CARBON	91K 5% 1/6W	R148	1-247-835-00	CARBON	1.5K 5% 1/6W
R045	1-247-855-00	CARBON	10K 5% 1/6W	R152	1-247-829-00	CARBON	820 5% 1/6W
R046	1-247-853-00	CARBON	8.2K 5% 1/6W	R153	1-247-843-00	CARBON	3.3K 5% 1/6W
R049	1-247-873-00	CARBON	56K 5% 1/6W	R157	1-247-867-00	CARBON	33K 5% 1/6W
R051	1-247-839-00	CARBON	2.2K 5% 1/6W	R159	1-247-819-00	CARBON	330 5% 1/6W
R052	1-247-807-00	CARBON	100 5% 1/6W	R167	1-247-835-00	CARBON	1.5K 5% 1/6W
R053	1-247-871-00	CARBON	47K 5% 1/6W	R173	1-247-847-00	CARBON	4.7K 5% 1/6W
R054	1-247-871-00	CARBON	47K 5% 1/6W	R176	1-247-887-00	CARBON	220K 5% 1/6W
R100	1-247-853-00	CARBON	8.2K 5% 1/6W	R177	1-247-879-00	CARBON	100K 5% 1/6W
R101	1-247-869-00	CARBON	39K 5% 1/6W	R185	1-247-877-00	CARBON	82K 5% 1/6W
R102	1-247-815-00	CARBON	220 5% 1/6W	R186	1-247-823-00	CARBON	470 5% 1/6W
R103	1-247-833-00	CARBON	1.2K 5% 1/6W	R187	1-247-865-00	CARBON	27K 5% 1/6W
R104	1-247-819-00	CARBON	330 5% 1/6W	R188	1-247-867-00	CARBON	33K 5% 1/6W
R105	1-247-827-00	CARBON	680 5% 1/6W	R189	1-247-875-00	CARBON	68K 5% 1/6W
R106	1-247-843-00	CARBON	3.3K 5% 1/6W	R192	1-247-891-00	CARBON	330K 5% 1/6W
R107	1-247-849-00	CARBON	5.6K 5% 1/6W	R193	1-247-845-00	CARBON	3.9K 5% 1/6W
R108	1-247-855-00	CARBON	10K 5% 1/6W	R194	1-247-859-00	CARBON	15K 5% 1/6W
R109	1-247-823-00	CARBON	470 5% 1/6W	R195	1-247-839-00	CARBON	2.2K 5% 1/6W
R110	1-247-823-00	CARBON	470 5% 1/6W	R196	1-247-865-00	CARBON	27K 5% 1/6W
R111	1-247-839-00	CARBON	2.2K 5% 1/6W	R197	1-247-827-00	CARBON	680 5% 1/6W
R112	1-247-827-00	CARBON	680 5% 1/6W	R199	1-247-831-00	CARBON	1K 5% 1/6W
R113	1-247-817-00	CARBON	270 5% 1/6W	R200	1-247-879-00	CARBON	100K 5% 1/6W
R114	1-247-827-00	CARBON	680 5% 1/6W	R210	1-247-815-00	CARBON	220 5% 1/6W
R115	1-247-835-00	CARBON	1.5K 5% 1/6W	R211	1-247-815-00	CARBON	220 5% 1/6W
R116	1-247-803-00	CARBON	68 5% 1/6W	R212	1-247-845-00	CARBON	3.9K 5% 1/6W
R117	1-247-827-00	CARBON	680 5% 1/6W	R218	1-247-855-00	CARBON	10K 5% 1/6W
R118	1-247-827-00	CARBON	680 5% 1/6W	R219	1-247-849-00	CARBON	5.6K 5% 1/6W
R119	1-247-807-00	CARBON	100 5% 1/6W	R220	1-247-867-00	CARBON	33K 5% 1/6W
R120	1-247-827-00	CARBON	680 5% 1/6W	R221	1-247-869-00	CARBON	39K 5% 1/6W
R121	1-247-827-00	CARBON	680 5% 1/6W	R222	1-247-875-00	CARBON	68K 5% 1/6W
R122	1-247-807-00	CARBON	100 5% 1/6W	R224	1-247-891-00	CARBON	330K 5% 1/6W
R123	1-247-831-00	CARBON	1K 5% 1/6W	R227	1-247-839-00	CARBON	2.2K 5% 1/6W
R124	1-247-823-00	CARBON	470 5% 1/6W	R230	1-247-847-00	CARBON	4.7K 5% 1/6W
R125	1-247-831-00	CARBON	1K 5% 1/6W	R231	1-247-873-00	CARBON	56K 5% 1/6W
R126	1-247-807-00	CARBON	100 5% 1/6W	R239	1-247-877-00	CARBON	82K 5% 1/6W
R127	1-247-827-00	CARBON	680 5% 1/6W	R240	1-247-838-00	CARBON	2K 5% 1/6W
R128	1-247-814-00	CARBON	200 5% 1/6W	R241	1-247-863-00	CARBON	22K 5% 1/6W
R129	1-247-835-00	CARBON	1.5K 5% 1/6W	R242	1-247-854-00	CARBON	9.1K 5% 1/6W
R130	1-247-827-00	CARBON	680 5% 1/6W	R243	1-247-857-00	CARBON	12K 5% 1/6W
R131	1-247-823-00	CARBON	470 5% 1/6W	R244	1-247-843-00	CARBON	3.3K 5% 1/6W
R132	1-247-837-00	CARBON	1.8K 5% 1/6W	R245	1-247-849-00	CARBON	5.6K 5% 1/6W
R133	1-247-799-00	CARBON	47 5% 1/6W	R246	1-247-855-00	CARBON	10K 5% 1/6W
R135	1-247-815-00	CARBON	220 5% 1/6W	R247	1-247-859-00	CARBON	15K 5% 1/6W
R136	1-247-839-00	CARBON	2.2K 5% 1/6W	R248	1-247-839-00	CARBON	2.2K 5% 1/6W
R137	1-247-861-00	CARBON	18K 5% 1/6W	R249	1-247-871-00	CARBON	47K 5% 1/6W
R138	1-247-843-00	CARBON	3.3K 5% 1/6W	R250	1-247-885-00	CARBON	180K 5% 1/6W
R140	1-247-863-00	CARBON	22K 5% 1/6W	R251	1-247-849-00	CARBON	5.6K 5% 1/6W
R141	1-247-863-00	CARBON	22K 5% 1/6W	R252	1-247-853-00	CARBON	8.2K 5% 1/6W
R143	1-247-807-00	CARBON	100 5% 1/6W	R253	1-247-843-00	CARBON	3.3K 5% 1/6W
R144	1-247-863-00	CARBON	22K 5% 1/6W	R254	1-247-855-00	CARBON	10K 5% 1/6W
				R255	1-247-831-00	CARBON	1K 5% 1/6W

PVM-1910/1911

B TK-09

Ref.No	Part No.	Description	Remark
R256	1-247-853-00	CARBON 8.2K 5% 1/6W	
R258	1-247-839-00	CARBON 2.2K 5% 1/6W	
R259	1-247-853-00	CARBON 8.2K 5% 1/6W	
R273	1-246-545-00	CARBON 1M 5% 1/4W	
R275	1-247-855-00	CARBON 10K 5% 1/6W	
R276	1-247-859-00	CARBON 15K 5% 1/6W	
R277	1-247-829-00	CARBON 820 5% 1/6W	
R278	1-247-840-00	CARBON 2.4K 5% 1/6W	
R279	1-246-509-00	CARBON 33K 5% 1/4W	
R280	1-247-871-00	CARBON 47K 5% 1/6W	
R281	1-247-859-00	CARBON 15K 5% 1/6W	
R282	1-247-839-00	CARBON 2.2K 5% 1/8W	F
R283	1-247-847-00	CARBON 4.7K 5% 1/6W	
R284	1-247-853-00	CARBON 8.2K 5% 1/6W	
R285	1-247-843-00	CARBON 3.3K 5% 1/6W	
R286	1-247-843-00	CARBON 3.3K 5% 1/6W	
R287	1-247-903-00	CARBON 1M 5% 1/6W	
R288	1-247-879-00	CARBON 100K 5% 1/6W	
R291	1-247-855-00	CARBON 10K 5% 1/6W	
R292	1-246-401-00	CARBON 1 5% 1/4W	
R293	1-247-841-00	CARBON 2.7K 5% 1/6W	
R294	1-247-807-00	CARBON 100 5% 1/6W	
R295	1-247-847-00	CARBON 4.7K 5% 1/6W	
R297	1-247-871-00	CARBON 47K 5% 1/6W	
R298	1-247-871-00	CARBON 47K 5% 1/6W	
R299	1-247-823-00	CARBON 470 5% 1/6W	
R301	1-247-658-00	CARBON 47 5% 1/4W	F
R302	1-247-871-00	CARBON 47K 5% 1/6W	
R306	1-247-883-00	CARBON 150K 5% 1/6W	
R307	1-247-819-00	CARBON 330 5% 1/6W	
R308	1-247-865-00	CARBON 27K 5% 1/6W	
R309	1-247-815-00	CARBON 220 5% 1/6W	
R310	1-247-843-00	CARBON 3.3K 5% 1/6W	
R311	1-247-872-00	CARBON 51K 5% 1/6W	
R315	1-247-835-00	CARBON 1.5K 5% 1/6W	
R316	1-247-835-00	CARBON 1.5K 5% 1/6W	
R319	1-247-823-00	CARBON 470 5% 1/6W	
R322	1-247-851-00	CARBON 6.8K 5% 1/6W	
R326	1-247-845-00	CARBON 3.9K 5% 1/6W	
R327	1-247-783-00	CARBON 10 5% 1/8W	F
R328	1-247-838-00	CARBON 2K 5% 1/6W	
R329	1-247-845-00	CARBON 3.9K 5% 1/6W	
R330	1-247-831-00	CARBON 1K 5% 1/6W	
R331	1-247-863-00	CARBON 22K 5% 1/6W	
R335	1-247-871-00	CARBON 47K 5% 1/6W	
R336	1-247-863-00	CARBON 22K 5% 1/6W	
R337	1-247-875-00	CARBON 68K 5% 1/6W	
R338	1-247-855-00	CARBON 10K 5% 1/6W	
R339	1-247-839-00	CARBON 2.2K 5% 1/6W	
R340	1-247-815-00	CARBON 220 5% 1/6W	
R341	1-247-855-00	CARBON 10K 5% 1/6W	
R342	1-247-841-00	CARBON 2.7K 5% 1/6W	
R343	1-247-831-00	CARBON 1K 5% 1/6W	

Ref.No	Part No.	Description	Remark
R344	1-247-831-00	CARBON 1K 5% 1/6W	
R345	1-247-841-00	CARBON 2.7K 5% 1/6W	
R346	1-247-841-00	CARBON 2.7K 5% 1/6W	
R347	1-247-845-00	CARBON 3.9K 5% 1/6W	
R348	1-247-857-00	CARBON 12K 5% 1/6W	
R349	1-247-855-00	CARBON 10K 5% 1/6W	

VARIABLE RESISTOR

RV101	1-228-718-00	RES, ADJ, CERAMIC CARBON 330	
RV103	1-228-722-00	RES, ADJ, CERAMIC CARBON 3.3K	
RV104	1-228-725-00	RES, ADJ, CERAMIC CARBON 22K	
RV106	1-228-722-00	RES, ADJ, CERAMIC CARBON 3.3K	
RV107	1-228-724-00	RES, ADJ, CERAMIC CARBON 10K	
RV108	1-228-723-00	RES, ADJ, CERAMIC CARBON 4.7K	
RV109	1-228-723-00	RES, ADJ, CERAMIC CARBON 4.7K	
RV111	1-228-727-00	RES, ADJ, CERAMIC CARBON 47K	

SWITCH

S1	1-553-725-00	SWITCH, SLIDE	
S2	1-553-725-00	SWITCH, SLIDE	
S3	1-553-725-00	SWITCH, SLIDE	

TRANSFORMER

T101	1-408-513-00	COIL (VARIABLE)	
T102	1-409-193-00	COIL 3.58MHZ TRAP	

THERMISTOR

TH101	1-800-070-XX	THERMISTOR TH-4700	
TH201	1-800-626-00	THERMISTOR	

CRYSTAL

X101	1-527-396-00	CRYSTAL, OSC	
------	--------------	--------------	--

▲.1-413-179-11 SWITCHING REGULATOR (TK-09)

- ▲:1-611-903-11 TK-09GB BOARD
- 2-430-308-01 INSULATOR (TK-03), TR
- ▲:2-430-742-00 BRACKET-RIGHT (SR-12), L
- ▲:2-430-743-00 BRACKET-LEFT (SR-12)
- 2-430-773-01 +PSW 3X6
- ▲:2-430-947-00 PLATE, GROUND
- 2-434-060-01 +PSW 3X18
- 3-671-893-00 CLAMP (LOW TYPE)
- ▲:4-310-385-00 HOLDER, WIRE
- ▲:4-323-833-00 HEAT SINK, PIN OUT

CAPACITOR

C601	▲.1-130-806-21	FILM 0.10MF	10%	400V	
C602	▲.1-161-742-12	CERAMIC 2200PF	20%	400V	F
C603	▲.1-161-742-12	CERAMIC 2200PF	20%	400V	F
C604	▲.1-161-742-12	CERAMIC 2200PF	20%	400V	F

The components identified by shading and mark ▲ are critical for safety. Replace only with part number specified.

Les composants identifiés par une trame et une marque ▲ sont critiques pour la sécurité. Ne les remplacer que par une pièce portant le numéro spécifié.

Ref.No	Part No.	Description	Remark	Ref.No	Part No.	Description	Remark
C605	△.1-125-268-11	ELECT					
C606	△.1-124-023-51	ELECT	4.7MF				350V
C607	△.1-124-023-41	ELECT	4.7MF				350V
C610	△.1-161-963-11	CERAMIC	100PF	20%			2V
C611	△.1-161-912-11	CERAMIC	560PF	10%			500V
C612	△.1-161-912-11	CERAMIC	560PF	10%			500V
C613	△.1-161-912-11	CERAMIC	560PF	10%			500V
C614	△.1-161-912-11	CERAMIC	560PF	10%			500V
C615	△.1-161-989-11	CERAMIC	2200PF	10%			500V
C616	△.1-130-516-51	FILM	0.01MF	10%			50V
C617	△.1-130-520-51	FILM	0.022MF	10%			50V
C618	△.1-123-357-51	ELECT	22MF	20%			50V
C619	△.1-130-528-51	FILM	0.1MF	10%			50V
C620	△.1-123-575-51	ELECT	100MF				160V
C621	△.1-123-349-51	ELECT	1000MF	20%			35V
C622	△.1-123-324-51	ELECT	1000MF	20%			16V
C623	△.1-123-575-51	ELECT	100MF				160V
C624	△.1-123-333-51	ELECT	100MF	20%			25V
C625	△.1-123-333-51	ELECT	100MF	20%			25V
C651	△.1-130-528-51	FILM	0.1MF	10%			50V
C652	△.1-130-528-51	FILM	0.1MF	10%			50V
C653	△.1-124-265-11	ELECT	33MF				50V
C654	△.1-130-027-51	FILM	0.0056MF	5%			50V
C655	△.1-130-512-51	FILM	0.0047MF	10%			50V
C656	△.1-130-528-51	FILM	0.1MF	10%			50V
C657	△.1-123-330-51	ELECT	22MF	20%			25V
<u>CONNECTOR</u>							
CN651	△.1-564-164-11	PIN, CONNECTOR	7P				
<u>DIODE</u>							
D601	△.8-719-300-53	DIODE	CTU-38S				
D602	△.8-719-300-52	DIODE	CTU-38R				
D603	△.8-719-903-02	DIODE	ESAC33-02C				
D604	△.8-719-903-02	DIODE	ESAC33-02C				
D605	△.8-719-900-93	DIODE	V09E				
D606	△.8-719-911-19	DIODE	1SS119				
D607	△.8-719-100-61	DIODE	RD11E-B2				
D608	△.8-719-100-34	DIODE	RD5.6E-B1				
D609	△.8-719-100-29	DIODE	RD5.1E-B1				
D610	△.8-719-100-29	DIODE	RD5.1E-B1				
D611	△.8-719-200-02	DIODE	10E2				
D612	△.8-719-100-34	DIODE	RD5.6E-B1				
D613	△.8-719-100-34	DIODE	RD5.6E-B1				
D651	△.8-719-911-19	DIODE	1SS119				
D652	△.8-719-911-19	DIODE	1SS119				
D653	△.8-719-911-19	DIODE	1SS119				
D654	△.8-719-100-34	DIODE	RD5.6E-B1				
<u>IC</u>							
IC651	△.8-759-906-22	IC	MB3759PF				
				<u>COIL</u>			
L601	△.1-421-606-11	TRANSFORMER,	LINE FILTER				
L602	△.1-410-052-11	COIL, CHOKE	(MAIN)				
L603	△.1-410-053-11	COIL, CHOKE					
L604	△.1-408-933-11	COIL, CHOKE					
L605	△.1-408-933-11	COIL, CHOKE					
L606	△.1-408-933-11	COIL, CHOKE					
				<u>TRANSISTOR</u>			
Q601	△.8-729-300-95	TRANSISTOR	STR8124				
Q602	△.8-729-102-03	TRANSISTOR	2SD1020				
Q603	△.8-729-102-03	TRANSISTOR	2SD1020				
Q604	△.8-729-178-54	TRANSISTOR	2SC2785				
Q605	.8-729-177-43	TRANSISTOR	2SD774				
Q651	△.8-729-117-54	TRANSISTOR	2SA1175				
Q652	△.8-729-178-54	TRANSISTOR	2SC2785				
				<u>RESISTOR</u>			
R601	△.1-244-921-11	CARBON	100K	5%	1/2W		
R602	△.1-246-497-25	CARBON	10K	5%	1/4W		
R603	△.1-212-946-51	FUSE	3.3	5%	1/2W		
R604	△.1-246-449-25	CARBON	100	5%	1/4W		
R605	△.1-244-921-11	CARBON	100K	5%	1/2W		
R606	△.1-246-497-25	CARBON	10K	5%	1/4W		
R607	△.1-212-946-51	FUSE	3.3	5%	1/2W		
R608	△.1-246-449-25	CARBON	100	5%	1/4W		
R609	△.1-244-873-11	CARBON	1K	5%	1/2W		
R610	△.1-246-461-25	CARBON	330	5%	1/4W		
R611	△.1-246-521-25	CARBON	100K	5%	1/4W		
R612	△.1-246-497-25	CARBON	10K	5%	1/4W		
R613	△.1-246-482-25	CARBON	2.4K	5%	1/4W		
R615	△.1-213-151-61	METAL	4.7K	5%	1W		
R616	△.1-246-453-25	CARBON	150	5%	1/4W		
R617	△.1-246-417-25	CARBON	4.7	5%	1/4W		
R618	△.1-217-465-21	FUSE	0.47	10%	1W		
R619	△.1-217-465-21	FUSE	0.47	10%	1W		
R620	△.1-246-418-25	CARBON	5.1	5%	1/4W		
R651	△.1-247-855-41	CARBON	10K	5%	1/6W		
R652	△.1-247-845-41	CARBON	3.9K	5%	1/6W		
R653	△.1-247-862-41	CARBON	20K	5%	1/6W		
R654	△.1-247-864-41	CARBON	24K	5%	1/6W		
R655	△.1-247-836-41	CARBON	1.6K	5%	1/6W		
R656	△.1-247-879-41	CARBON	100K	5%	1/6W		
R657	△.1-247-835-41	CARBON	1.5K	5%	1/6W		
R658	△.1-247-881-41	CARBON	120K	5%	1/6W		
R659	△.1-247-854-41	CARBON	9.1K	5%	1/6W		
R660	△.1-214-777-51	METAL	100K	1%	1/4W		
R661	△.1-214-744-51	METAL	4.3K	1%	1/4W		
R662	△.1-247-861-41	CARBON	18K	5%	1/6W		
R663	△.1-247-852-41	CARBON	7.5K	5%	1/6W		
R664	△.1-247-846-41	CARBON	4.3K	5%	1/6W		
R665	△.1-247-849-41	CARBON	5.6K	5%	1/6W		

The components identified by shading and mark △ are critical for safety. Replace only with part number specified.

Les composants identifiés par une trame et une marque △ sont critiques pour la sécurité. Ne les remplacer que par une pièce portant le numéro spécifié.

PVM-1910/1911

TK-09

M

Ref.No	Part No.	Description	Remark	Ref.No	Part No.	Description	Remark
R666	△.1-247-831-41	CARBON	1.0K 5% 1/6W	C40	1-161-025-00	CERAMIC	0.1MF 12V
R667	△.1-247-837-41	CARBON	1.8K 5% 1/6W	C41	1-161-025-00	CERAMIC	0.1MF 12V
<u>VARIABLE RESISTOR</u>				C42	1-161-025-00	CERAMIC	0.1MF 12V
RV651	△.1-228-141-11	RES, VAR. 500		C43	1-161-025-00	CERAMIC	0.1MF 12V
<u>TRANSFORMER</u>				C44	1-161-025-00	CERAMIC	0.1MF 12V
T601	△.1-447-764-11	TRANSFORMER, CONVERTER		C45	1-161-025-00	CERAMIC	0.1MF 12V
T602	△.1-437-102-12	TRANSFORMER, DRIVE		C46	1-161-025-00	CERAMIC	0.1MF 12V
T603	△.1-421-460-11	TRANSFORMER, CURRENT		C47	1-102-820-00	CERAMIC	330PF 5% 50V
*****				C48	1-161-025-00	CERAMIC	0.1MF 12V
◆:A-1306-304-A M BOARD, COMPLETE (PVM-1911 ONLY)				C49	1-161-051-00	CERAMIC	0.01MF 10% 50V
*****				C52	1-161-051-00	CERAMIC	0.01MF 10% 50V
◆:4-363-146-00 HEAT SINK, V.OUT				C050	1-102-957-00	CERAMIC	18PF 10% 50V
<u>CAPACITOR</u>				C051	1-102-957-00	CERAMIC	18PF 10% 50V
C1	1-161-051-00	CERAMIC	0.01MF 10% 50V	<u>CONNECTOR</u>			
C2	1-123-356-00	ELECT	10MF 20% 16V	CN1	◆:1-560-295-00	PIN, CONNECTOR 7P	
C3	1-123-669-51	ELECT	33MF 20% 16V	CN2	◆:1-564-467-11	CONNECTOR (FLAT CABLE) 26P	
C4	1-161-053-00	CERAMIC	0.015MF 10% 50V	CN3	◆:1-564-466-11	CONNECTOR (FLAT CABLE) 34P	
C5	1-161-053-00	CERAMIC	0.015MF 10% 50V	CN4	◆:1-560-290-00	PLUG, CONNECTOR (2.5MM PITCH)	
C6	1-161-053-00	CERAMIC	0.015MF 10% 50V	CN5	◆:1-560-295-00	PIN, CONNECTOR 7P	
C7	1-161-053-00	CERAMIC	0.015MF 10% 50V	<u>DIODE</u>			
C8	1-161-053-00	CERAMIC	0.015MF 10% 50V	D3	8-719-920-04	DIODE ERB12-02RK	
C9	1-161-053-00	CERAMIC	0.015MF 10% 50V	D6	8-719-911-19	DIODE 1SS119	
C10	1-161-053-00	CERAMIC	0.015MF 10% 50V	<u>FUSE</u>			
C11	1-161-053-00	CERAMIC	0.015MF 10% 50V	F1	△.1-532-580-11	FUSE, GLASS TUBE	
C12	1-161-053-00	CERAMIC	0.015MF 10% 50V	◆:1-533-146-00 HOLDER, FUSE, F1			
C13	1-161-053-00	CERAMIC	0.015MF 10% 50V	<u>IC</u>			
C14	1-161-053-00	CERAMIC	0.015MF 10% 50V	IC1	8-759-900-04	IC SN74LS04N	
C15	1-161-053-00	CERAMIC	0.015MF 10% 50V	IC2	8-759-901-23	IC SN74LS123N	
C16	1-161-053-00	CERAMIC	0.015MF 10% 50V	IC3	8-759-951-88	IC SN75188N	
C17	1-161-053-00	CERAMIC	0.015MF 10% 50V	IC4	8-759-900-86	IC SN74LS86N	
C18	1-161-053-00	CERAMIC	0.015MF 10% 50V	IC5	8-759-951-89	IC SN75189AN	
C19	1-161-053-00	CERAMIC	0.015MF 10% 50V	IC6	8-759-220-04	IC TC40H004P	
C20	1-161-053-00	CERAMIC	0.015MF 10% 50V	IC7	8-759-200-05	IC TC40H008P	
C21	1-161-053-00	CERAMIC	0.015MF 10% 50V	IC8	8-759-220-32	IC TC40H032P	
C22	1-161-053-00	CERAMIC	0.015MF 10% 50V	IC9	8-759-640-80	IC CX564-080	
C23	1-161-053-00	CERAMIC	0.015MF 10% 50V	IC10	8-759-220-04	IC TC40H004P	
C24	1-161-053-00	CERAMIC	0.015MF 10% 50V	IC11	8-759-220-04	IC TC40H004P	
C25	1-161-053-00	CERAMIC	0.015MF 10% 50V	IC12	8-759-220-04	IC TC40H004P	
C26	1-161-053-00	CERAMIC	0.015MF 10% 50V	IC13	8-759-220-04	IC TC40H004P	
C27	1-161-053-00	CERAMIC	0.015MF 10% 50V	IC14	8-759-371-54	IC HD74LS154P	
C28	1-123-322-00	ELECT	330MF 20% 16V	IC15	8-759-371-54	IC HD74LS154P	
C29	1-123-322-00	ELECT	330MF 20% 16V	IC16	8-759-904-97	IC TL497ACN	
C30	1-123-321-00	ELECT	220MF 20% 16V	IC17	8-759-904-97	IC TL497ACN	
C31	1-102-820-00	CERAMIC	330PF 5% 50V	IC18	8-759-170-05	IC UPC78M05H	
C34	1-123-356-00	ELECT	10MF 20% 16V	<u>COIL</u>			
C37	1-161-025-00	CERAMIC	0.1MF 12V	L1	1-408-423-00	MICRO INDUCTOR 150UH	
C38	1-161-025-00	CERAMIC	0.1MF 12V	L2	1-408-428-00	MICRO INDUCTOR 390UH	
C39	1-161-025-00	CERAMIC	0.1MF 12V				

The components identified by shading and mark △ are critical for safety. Replace only with part number specified.

Les composants identifiés par une trame et une marque △ sont critiques pour la sécurité. Ne les remplacer que par une pièce portant le numéro spécifié.

PVM-1910/1911

SONY®
SERVICE MANUAL

US Model
Canadian Model

PVM-1910
Chassis No. SCC-554A-A

PVM-1911
Chassis No. SCC-556A-A

SUPPLEMENT -1

File this supplement-1 with the service manual.

SUBJECT: ADDITION OF INSTRUCTIONS.

This supplement adds the instruction of PVM-1911.

SPECIFICATIONS

Number of switches
768 [32 (horizontal) × 24 (vertical)]

Pressure requirement
20 g to 180 g

Controller LSI
CX-564-080
(ROM 4 Kbyte)

Communication protocol
Baud rate: 1200 bauds to
4800 bauds
Character length: 8 bits
Stop bits: any bits
Parity check: no

Dimensions of screen
352 × 264 mm (w/h)
(13⁷/₈ × 10¹/₂ inches)

Design and specifications subject to change without notice.



MON

TABLE OF CONTENTS

The touch screen is used to obtain a screen address by placing your finger at the desired position on the display screen. It provides a variety of interactive uses of a computer.

Parts identification.....	2
System connection.....	3
Usage examples.....	4
The principle of operation	5
How to control	5
Program examples.....	8
Specifications	9
Pin assignment	9

PARTS IDENTIFICATION

Front panel

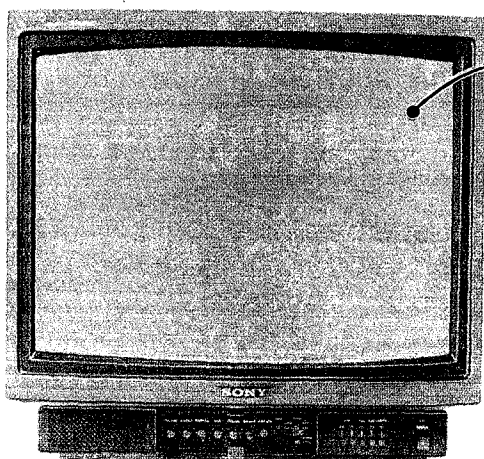

Touch screen
To obtain a screen address, place your finger at the desired position on the displayed screen.

Rear panel

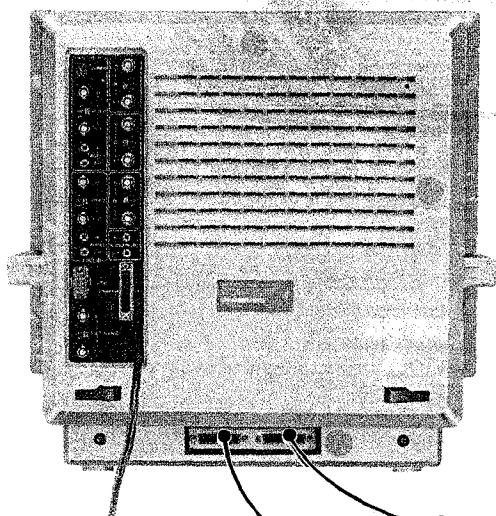

COMPUTER connector (RS-232C)

EXT connector (RS-232C)

For signal arrangement, see "Pin assignment" on page 9.

SYSTEM CONNECTION

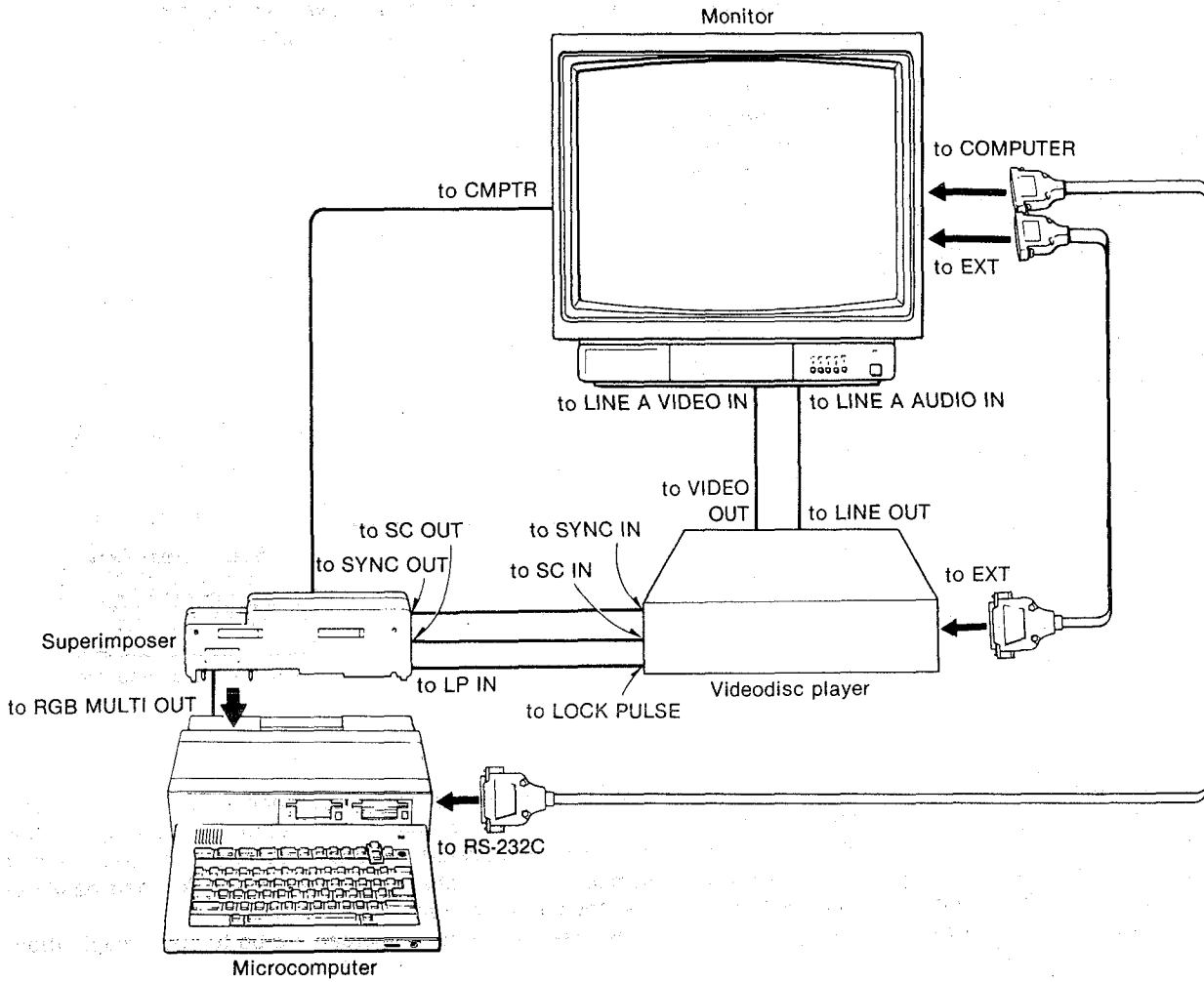

Notes

● The SMC-70/70G has an internal switch to select the direction of signal flow. When connecting the monitor to the SMC-70/70G, the switch should be set to TO TRMNL. Use the SMK-0031 RS-232C interface cable to connect the monitor to the SMC-70/70G.

● When a superimposer is used, connect a videodisc player to the **LINE A VIDEO IN** connector and the **LINE A AUDIO IN** jack of the monitor.

● For details on connecting a superimposer and a microcomputer, please refer to each manual.

USAGE EXAMPLES

The touch screen is used to make selections by simply placing your finger on an item displayed on the screen. A variety of uses is possible in combination with a computer and other equipment such as a videodisc player.

The touch screen, which is controlled by the host computer through the RS-232C interface, can be used in a variety of ways. For example, you would like to play one of your computer games. First, execute the program that will display the names of the games available on the screen. Then, simply touch the name of the game you want to play and will be set up. You do not need to use the computer keyboard to order up the game.

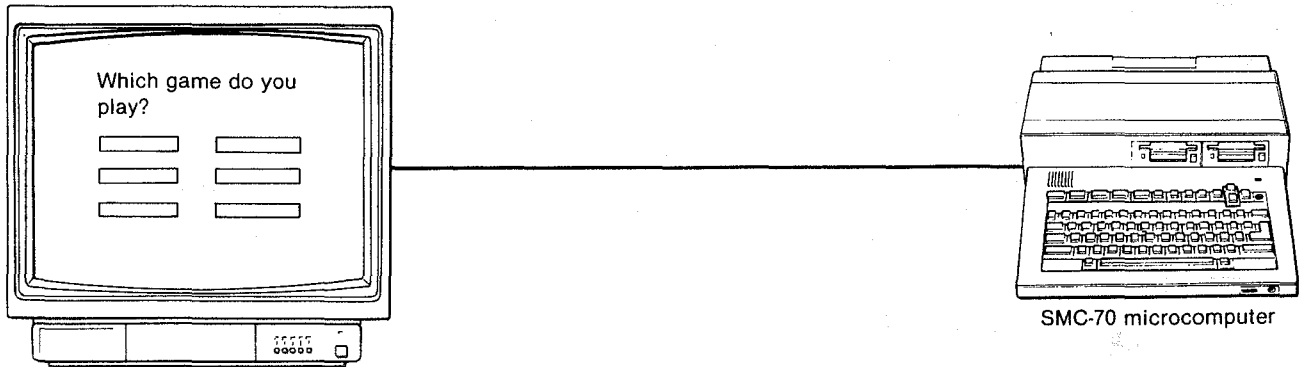

Another use of the touch screen would be in conjunction with Sony's LDP-1000A videodisc player and the SMI-7073/7074 superimposer. The three units are controlled by a host computer such as the SMC-70 micro computer. Suppose you would like to check the weather in cities around the world. First, have the computer command the videodisc player to

display a world map. Then superimpose some symbols over the cities. Next execute on the computer the program that will give you the weather data of the city when you touch its symbol. You can check the weather quickly and easily by just touching the screen.

Other uses of the touch screen are up to your imagination.

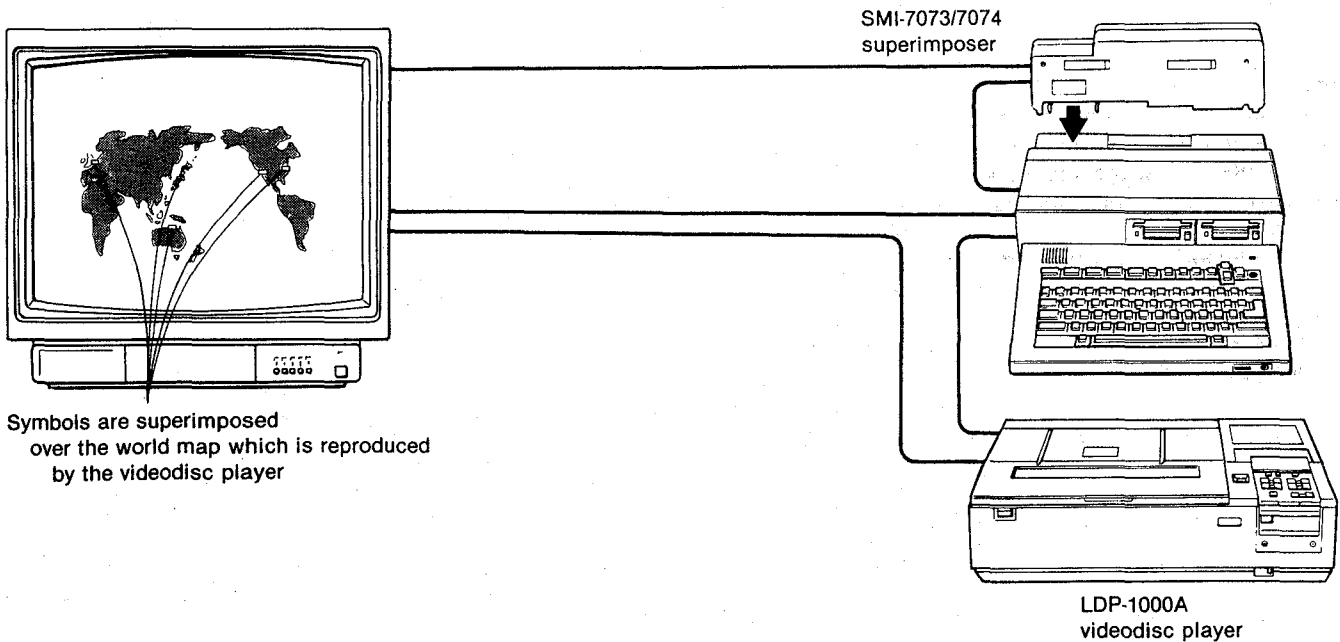

THE PRINCIPLE OF OPERATION

The touch screen is composed of 32 (horizontal)×24 (vertical) matrix of electronic switches. These switches are vertically scanned beginning from the upper left corner. The controller built in the monitor checks whether a switch is pressed, and stores up to eight pairs of coordinate data (X, Y) of the switch pressed in its internal buffer, irrespective of whether the host computer reads the data or not.

The host computer can obtain a screen address by reading the data stored in the controller through the RS-232C interface: Before reading each coordinate value, X and Y, output a pair of 55H and FFH data, which functions as the command to read data. The first data transferred from the controller is the Y data, and second one is the X. Coordinate data are represented in binary numbers.

HOW TO CONTROL

All of the connected units are controlled by the host computer. For control of units other than the touch screen, please refer to your computer manual.

PROTOCOL

When you use the touch screen, set the protocol of the communication interface of the host computer as follows.

Number of stop bits	Any bits
Parity check	No parity
Character length	8 bits
Baud rate	1200 bauds to 4800 bauds
Operating mode	Asynchronous mode

For details on initializing the RS-232C port, refer to your computer manual.

FLOW CHART

Communication between the controller and the host computer should proceed after initializing the RS-232C interface and displaying the necessary pattern for data input. The flow chart of data communication is shown below.

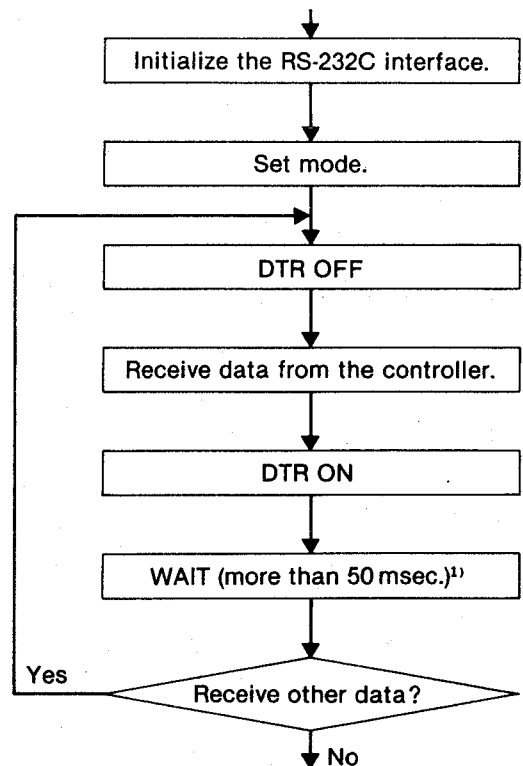

1) It takes about 30 msec to scan the entire screen once. To receive other data, more than 50 msec interval is necessary so that the controller becomes ready for sending data.

MODE SETTING

There are two modes of operation: mode 0 and mode 1. They are selected by the host computer. Use mode 0 to obtain the coordinates of a particular position and mode 1 to obtain the coordinates of a series of positions.

Mode 0: The coordinates of the switch pressed on the screen are stored directly in the buffer. When several switches are pressed simultaneously, up to eight pairs of coordinates (up to three rows of switches vertically) can be stored in the buffer. The data of these coordinates will be updated each time the screen is scanned.

For example, when you put your finger tip on the shaded area in the right illustration, eight pairs of coordinates shown are stored in the buffer.

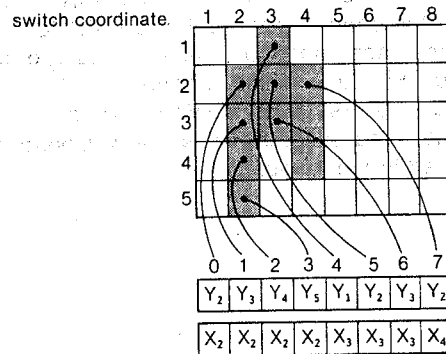

Mode 1 (double precision mode): One pair of coordinate data is stored at each scan. In this mode, the coordinate data is doubled logically and stored in the buffer as if there are 64 × 48 switches. When several switches are pressed simultaneously, the average value is stored. Up to eight pairs of

coordinates data will be held in the buffer, if different positions are pressed in sequence. When the buffer storage is filled, additional new positions pressed will cause the new coordinates to be written over the previous coordinate data in the buffer, in sequence starting with the first pair.

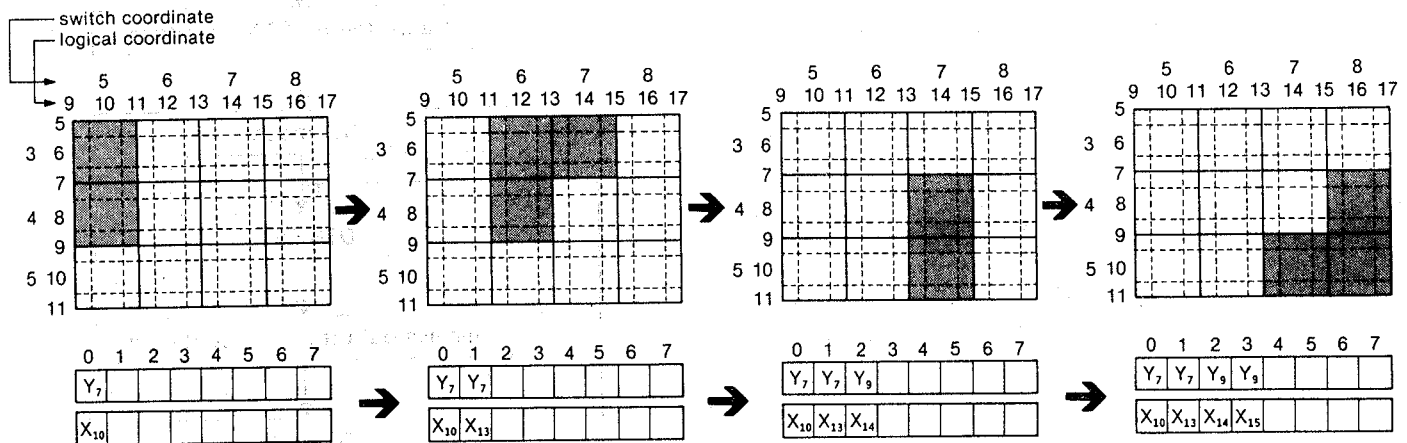

(The arrow signifies passage of time.)

How to set the mode: To set to mode 0 of the touch screen, output a pair of 55H and FFH data repeatedly twenty times without reading the coordinate data, and twenty-two times for mode 1.

RECEIVING DATA

Following chart shows the data flow and its bit assignment.

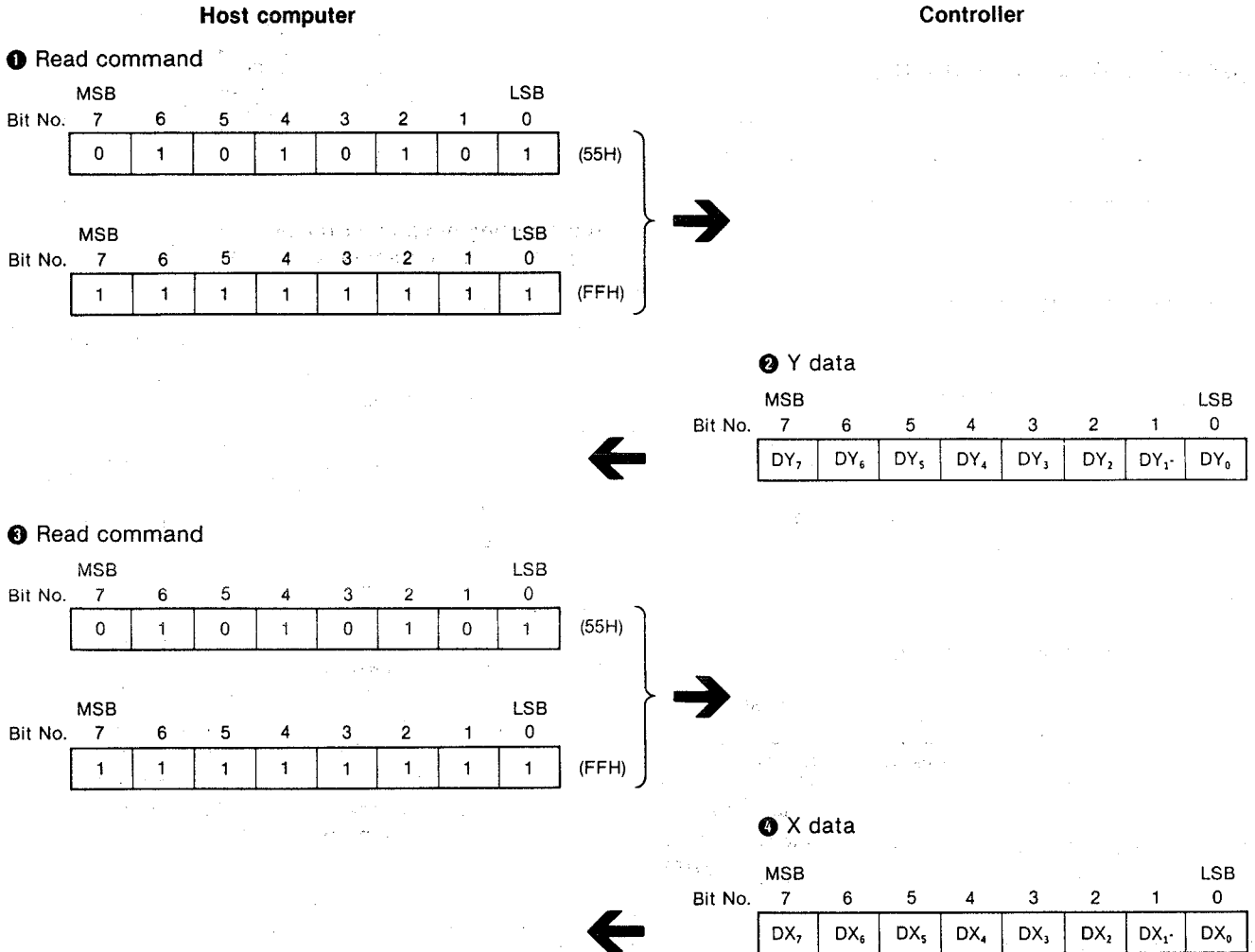

Note

If no switch is pressed in writing read command, the buffer is filled with FFH instead of the coordinate (X, Y) data.

RESET

If the controller is turned off and then turned on again, it is automatically reset to the initial state: the operating mode is set to mode 0 and the data in the buffer are all cleared. Once the controller is reset, it must be initialized before reading the data. The controller is reset by short power interruptions, which do not reset the host computer. In order

to show that this has happened, the framing error flag is effective. (In the SMC-70, this flag is assigned to bit 5 of the status data read through the RS-232C port.) When this flag is set, be sure to initialize the RS-232C interface of the controller. If necessary, reset the controller to the previous mode.

PROGRAM EXAMPLES

In the following program examples, the SMC-70 is used as the host computer. In the SMC-70 the RS-232C interface is controlled by the 8251A which is assigned to ports 26H and 27H. For details on the RS-232C interface control, please refer to "the SMC-70 Hardware: Reference Manual" (SML-7004).

Transmitted/received data: Port 26H

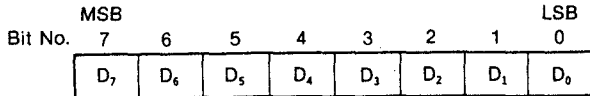

Initialization program example

```
LD    A,8FH
OUT   (27H),A
LD    A,8FH
OUT   (27H),A
LD    A,40H
OUT   (27H),A
LD    A,4EH
OUT   (27H),A
LD    A,37H
OUT   (27H),A
```

Mode setting: Port 27H (Writing)

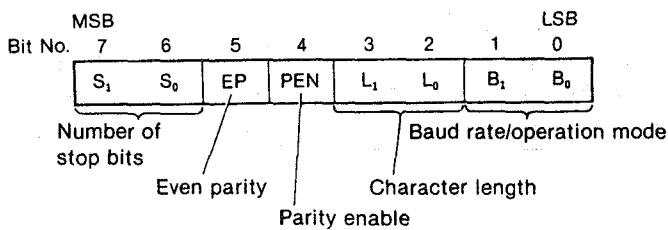

Mode setting program example

The following program sets mode 0.

```
PANDELAY:
LD    E,20 ; set counter
;
LD    A,35H ; DTR OFF
OUT   (27H),A
LOOP:
LD    A,55H
OUT   (26H),A ; send 55H
WAIT1:
IN    A,(27H)
BIT   0,A ; TxREADY ?
JR    Z,WAIT1
LD    A,0FFH
OUT   (26H),A ; send 0FFH
WAIT2:
IN    A,(27H)
BIT   2,A ; TxEMPTY ?
JR    Z,WAIT2
IN    A,(26H) ; get data
;
DEC   E ; decliment counter
JR    NZ,LOOP ; if counter is not 0
; then goto LOOP.
LD    A,37H
OUT   (27H),A ; DTR ON
```

Control instruction: Port 27H (Writing)

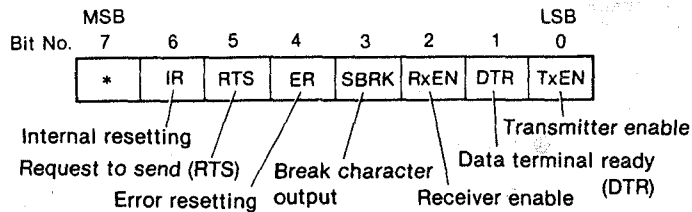

(Normally, the data value is 37H = 00110111H.)

Status data: Port 27H (Reading)

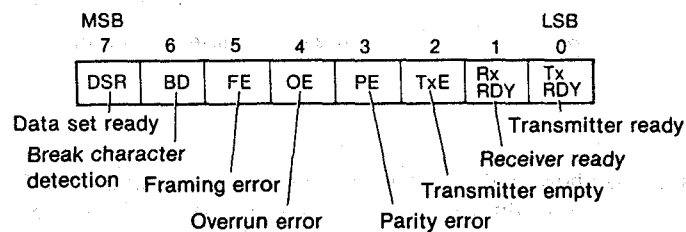

Data receiving program example

In this program, X data is to be stored in the address which DE register indicates, and Y data in the address HL register does.

```

LD      B,8           ; set read counter
LD      A,35H        ; DTR OFF
OUT     (<27H>),A

LOOP:   LD      A,55H
        OUT     (<26H>),A      ; send 55H

WAIT_Y: IN     A,<27H>
        BIT     0,A           ; TxREADY ?
        JR     Z,WAIT_Y
        LD      A,0FFH
        OUT     (<26H>),A      ; send 0FFH

READ_Y: IN     A,<27H>
        BIT     2,A           ; TxEMPTY ?
        JR     Z,READY
        IN     A,<26H>         ; read Y position
        LD      (<HL>),A      ; set data

:       LD      A,55H
        OUT     (<26H>),A      ; send 55H

WAIT_X: IN     A,<27H>
        BIT     0,A           ; TxREADY ?
        JR     Z,WAIT_X
        LD      A,0FFH
        OUT     (<26H>),A      ; send 0FFH

READ_X: IN     A,<27H>
        BIT     2,A           ; TxEMPTY ?
        JR     Z,READ_X
        IN     A,<26H>         ; read X position
        LD      (<DE>),A      ; set data

:       LD      A,00H
        INC     HL
        INC     DE
        LD      (<HL>),A
        LD      (<DE>),A
        INC     HL           ; pointer up
        INC     DE           ; pointer up
        DJNZ   LOOP          ; if counter is not 0
                                then goto LOOP.

:       LD      A,37H
        OUT     (<27H>),A      ; DTR ON
    
```

PIN ASSIGNMENT

The signal ratings conform to RS-232-C specifications.
(Output level ON: +9V, OFF: -9V)

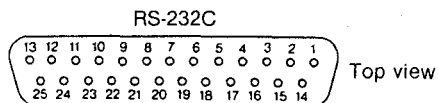

Mode Pin No.	Signal	Signal direction	
		CMPTR	EXT
1	Unused		
2	TxD	PVM-1911→	PVM-1911←
3	RxD	PVM-1911←	PVM-1911→
4	RTS	PVM-1911→	PVM-1911←
5	CTS	PVM-1911←	PVM-1911→
6	DSR	PVM-1911←	PVM-1911→
7	GND		
8—19	Unused		
20	DTR	PVM-1911→	PVM-1911←
21—25	Unused		

PVM-1910/1911

SONY
SERVICE MANUAL

US Model
Canadian Model

PVM-1910
Chassis No. SCC-554A-A



PVM-1911
Chassis No. SCC-556A-A

July, 1984
No. 2

CORRECTION

Correct the CORRECTION NO. 1 as shown below.

 indicates corrected portions

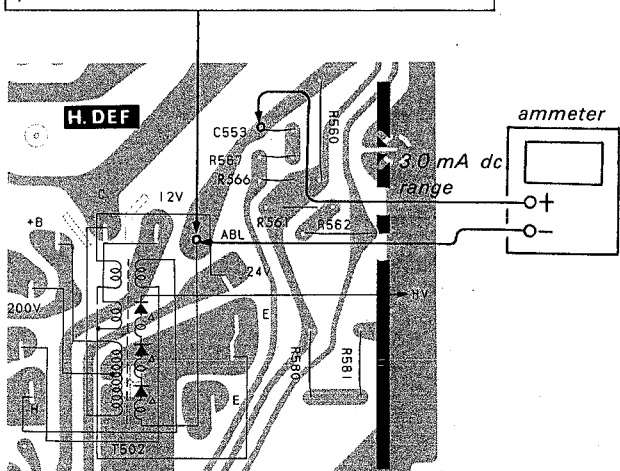
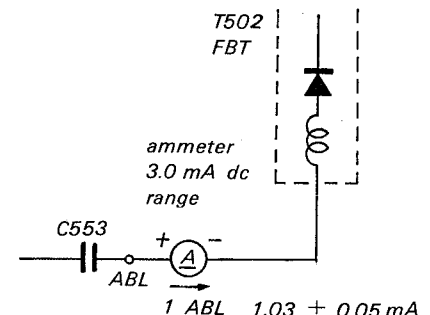
Page	Incorrect	Correct
22	<p>Hold Down Adjustment (✗ R543 Adjustment)</p> <p>Be sure to perform this after replacing the parts below (marked  on the schematic).</p> <p>D507, D508, D523, IC503, Q511, R540, R541, R542, R543, R544, R545, R590, R591, R592, R593</p> <p>Note: The ① pin of D-7 connector is the hold down check point (A).</p>	<p>SAFETY CIRCUIT Adjustment (✗ R543 Adjustment)</p> <p>Be sure to perform this after replacing the parts below (marked  on the schematic).</p> <p>D507, D508, D523, IC503, Q511, R540, R541, R542, R543, R544, R545, R590, R591, R592, R593, R546, R547</p> <p>Note: The ① pin of D-7 connector is the hold down check point (A).</p> <p>Disengage ABL terminal of FBT from the foil and connect the ammeter as shown to measure the ABL terminal current.</p>
	<p>Disengage the ABL terminal of FBT from the foil by un-soldering and connect negative probe to the ABL PIN of FBT.</p> 	
22	<p>5. Feed in an all-white signal.</p> <p>8. Adjust R543 so that steps 3, 4, 6 and 7 are satisfied.</p>	<p>5. Feed in an all-white signal and adjust ABL current to 1.03 ± 0.05 mA with PICTURE, BRIGHT, etc. VRs.</p> <p>8. Adjust R543 so that steps 3, 4, 6 and 7 are satisfied.</p> <p>9. Set the ABL terminal back to its original position.</p> <p>10. Confirm that the voltage on pin ① of D-7 connector is 12 — 16V DC at the normal condition.</p>



MON

Eliminate No. 8 of the O'VER VOLTAGE Protector Adjustment (R668 Adjustment) contained in CORRECTION No. 1, and add the following sentence.

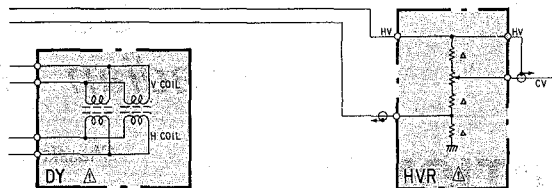

CHECKING AFTER H.V.R. REPLACEMENT

After replacing H.V.R., *confirm that there is more than 12.0V — 16.0V on Safety Circuit Check point (A).

* This check is to be performed when H.V.R. only is replaced, and has no relation to the HV Safety Circuit readjustment for replacement of parts marked (A).

23

CAUTION

When replacing HVR, be sure to check the HOLD DOWN check point voltage value. Refer to the safety related adjustments Section of the Service Manual.

PVM-1910/1911

SONY[®] SERVICE MANUAL

US Model
Canadian Model

PVM-1910
Chassis No. SCC-554A-A

PVM-1911
Chassis No. SCC-556A-A





June, 1984

No. 1

CORRECTION

Correct the service manual as shown below.

 indicates corrected portions

Page	Incorrect	Correct
22	<p>Hold Down Adjustment ( R543 Adjustment)</p> <p>Be sure to perform this after replacing the parts below (marked  on the schematic).</p> <p>D507, D508, D523, IC503, Q511, R540, R541, R542, R543, R544, R545, R590, R591, R592, R593</p> <p>Note: The ① pin of D-7 connector is the hold down check point (A).</p> <ol style="list-style-type: none"> 1. Feed in color-bar signal. 2. Set the BRIGHT, PICTURE & COLOR control to minimum. 3. Confirm that the HV HOLD DOWN CIRCUIT operates and the raster disappears when 18.50V DC is applied to hold down check point (A) from an external DC power supply. Note: When raster disappears, cut input voltage and applied voltage immediately. 4. Confirm that the HV HOLD DOWN CIRCUIT does not operate when 17.65V DC is applied to hold down check point (A) from an external DC power supply. Note: If the HV HOLD DOWN CIRCUIT operates, immediately cut input and applied voltage. 5. Feed in an all-white signal. 6. Confirm that the HV HOLD DOWN CIRCUIT operates and the raster disappears when 17.40V DC is applied to hold down check point (A) from an external DC power supply. Note: When raster disappears, cut input voltage and applied voltage immediately. 7. Confirm that the HV HOLD DOWN CIRCUIT does not operate when 16.30V DC is applied to hold down check point (A) from an external DC power supply. Note: If the HV HOLD DOWN CIRCUIT operates, immediately cut input and applied voltage. 8. Adjust R543 so that steps 3, 4, 6 and 7 are satisfied. 	<p>SAFETY CIRCUIT Adjustment ( R543 Adjustment)</p> <p>Be sure to perform this after replacing the parts below (marked  on the schematic).</p> <p>D507, D508, D523, IC503, Q511, R540, R541, R542, R543, R544, R545, R590, R591, R592, R593</p> <p>Note: The ① pin of D-7 connector is the hold down check point (A).</p> <ol style="list-style-type: none"> 1. Feed in color-bar signal. 2. Set the BRIGHT, PICTURE & COLOR control to minimum. 3. Confirm that the HV SAFETY CIRCUIT operates and the raster disappears when 18.50V DC is applied to hold down check point (A) from an external DC power supply. Note: When the picture is out of synchronize, turn off the set and cut the applied voltage immediately. 4. Confirm that the HV SAFETY CIRCUIT does not operate when 17.65V DC is applied to hold down check point (A) from an external DC power supply. Note: If the HV SAFETY CIRCUIT operates, immediately cut input and applied voltage. 5. Feed in an all-white signal. 6. Confirm that the HV SAFETY CIRCUIT operates and the raster disappears when 17.40V DC is applied to hold down check point (A) from an external DC power supply. Note: When raster disappears, cut input voltage and applied voltage immediately. 7. Confirm that the HV SAFETY CIRCUIT does not operate when 16.30V DC is applied to hold down check point (A) from an external DC power supply. Note: If the HV SAFETY CIRCUIT operates, immediately cut input and applied voltage. 8. Adjust R543 so that steps 3, 4, 6 and 7 are satisfied.

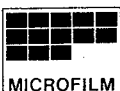

indicates corrected portions

Page	Incorrect	Correct																
23	<p>+B Adjustment (R669 Adjustment)</p> <p>Be sure to perform this after replacing the parts below (marked <input checked="" type="checkbox"/> on the schematic).</p> <p>C654, IC651, R652, R660, R661, R669</p> <ol style="list-style-type: none"> Supply 120V AC with variable auto-transformer. Adjust the resistance value of R669 so that +B voltage is $115.0V^{+1.0V}_{-2.0V}$ DC. <p>MAXIMUM +B VOLTAGE Adjustment (R668 Adjustment)</p> <p>Be sure to perform this after replacing the parts below (marked <input checked="" type="checkbox"/> on the schematic).</p> <p>D654, IC651, Q652, Q653, R658, R659, R666, R667, R668</p> <ol style="list-style-type: none"> Connect pin ① of IC651 to the ground with a jumper wire. Supply 130^{+2}_{-0} V AC to with variable auto-trans-within the former. Tune in an off air signal. Adjust the resistance value of R668 so that +B voltage is within the range of $115.0^{+1.0}_{-2.0}$ V DC. 	<p>MAXIMUM +B VOLTAGE Adjustment (R669 Adjustment)</p> <p>Be sure to perform this after replacing the parts below (marked <input checked="" type="checkbox"/> on the schematic).</p> <p>C654, IC651, R652, R660, R661, R669</p> <ol style="list-style-type: none"> Supply $130^{+2.0}_{-0}$ V AC with variable auto-transformer. Set BRIGHT and PICTURE controls minimum position and feed in an off air signal with a tuner. Adjust the resistance value of R669 so that +B voltage is $115.0V^{+1.0V}_{-2.0V}$ DC. <p>O'VER VOLTAGE Protector Adjustment (R668 Adjustment)</p> <p>Be sure to perform this after replacing the parts below (marked <input checked="" type="checkbox"/> on the schematic.)</p> <p>D654, IC651, Q652, Q653, R658, R659, R666, R667, R668</p> <ol style="list-style-type: none"> Connect pin ① of IC651 to the ground with a jumper wire. Supply 130^{+2}_{-0} V AC to with variable auto transformer. Feed in an off air signal with a tuner and set the BRIGHT, PICTURE & COLOR controls to minimum position. Adjust the resistance value of R668 so that +B voltage is within the $117.0 - 132.0V$ DC. Turn the power off and disconnect the jumper. Supply 120V AC to with variable auto-transformer. Confirm that the +B voltage is $115.0^{+1.0}_{-2.0}$ V DC. Confirm that the voltage on pin ① of D-7 connector is 12 - 16V DC at the normal condition. 																
33	<table border="1"> <thead> <tr> <th>Part replaced (<input checked="" type="checkbox"/>)</th> <th>Adjustment (<input checked="" type="checkbox"/>)</th> </tr> </thead> <tbody> <tr> <td>D507, D508, D523, IC503, Q511 R540, R541, R542, R543, R544 R545, R590, R591, R592, R593</td> <td>R543</td> </tr> <tr> <td>D654, IC651, Q652, Q653 R658 R659, R666, R667, R668</td> <td>R668</td> </tr> <tr> <td>C654, IC651, R652, R660, R661 R669</td> <td>R669</td> </tr> </tbody> </table>	Part replaced (<input checked="" type="checkbox"/>)	Adjustment (<input checked="" type="checkbox"/>)	D507, D508, D523, IC503, Q511 R540, R541, R542, R543, R544 R545, R590, R591, R592, R593	R543	D654, IC651, Q652, Q653 R658 R659, R666, R667, R668	R668	C654, IC651, R652, R660, R661 R669	R669	<table border="1"> <thead> <tr> <th>Part replaced (<input checked="" type="checkbox"/>)</th> <th>Adjustment (<input checked="" type="checkbox"/>)</th> </tr> </thead> <tbody> <tr> <td>D507, D508, D523, IC503, Q511 R540, R541, R542, R543, R544 R545, R546, R547, R590, R591 R592, R593</td> <td>R543</td> </tr> <tr> <td>D654, IC651, Q652, Q653 R658 R659, R666, R667, R668</td> <td>R668</td> </tr> <tr> <td>C654, IC651, R652, R660, R661 R669</td> <td>R669</td> </tr> </tbody> </table>	Part replaced (<input checked="" type="checkbox"/>)	Adjustment (<input checked="" type="checkbox"/>)	D507, D508, D523, IC503, Q511 R540, R541, R542, R543, R544 R545, R546, R547, R590, R591 R592, R593	R543	D654, IC651, Q652, Q653 R658 R659, R666, R667, R668	R668	C654, IC651, R652, R660, R661 R669	R669
Part replaced (<input checked="" type="checkbox"/>)	Adjustment (<input checked="" type="checkbox"/>)																	
D507, D508, D523, IC503, Q511 R540, R541, R542, R543, R544 R545, R590, R591, R592, R593	R543																	
D654, IC651, Q652, Q653 R658 R659, R666, R667, R668	R668																	
C654, IC651, R652, R660, R661 R669	R669																	
Part replaced (<input checked="" type="checkbox"/>)	Adjustment (<input checked="" type="checkbox"/>)																	
D507, D508, D523, IC503, Q511 R540, R541, R542, R543, R544 R545, R546, R547, R590, R591 R592, R593	R543																	
D654, IC651, Q652, Q653 R658 R659, R666, R667, R668	R668																	
C654, IC651, R652, R660, R661 R669	R669																	
39																		

M CN

Ref.No	Part No.	Description	Remark
<u>RESISTOR</u>			
R1	1-246-861-00	CARBON 30K 5% 1/8W	
R2	1-246-807-00	CARBON 100K 5% 1/8W	
R4	1-246-794-00	CARBON 8.2K 5% 1/8W	
R5	1-246-784-00	CARBON 1.2K 5% 1/8W	
R6	1-246-401-00	CARBON 1 5% 1/8W	
R7	1-246-784-00	CARBON 1.2K 5% 1/8W	
R8	1-246-794-00	CARBON 8.2K 5% 1/8W	
R10	1-246-401-00	CARBON 1 5% 1/8W	
<u>SWITCH</u>			
SW1	1-554-786-11	SWITCH, SLIDE	
<u>CRYSTAL</u>			
X1	1-527-827-00	OSCILLATOR, CRYSTAL	

ACCESSORIES AND PACKING MATERIALS

Part No.	Description	Remark
4-309-537-00	BAG, PROTECTION	
4-370-943-01	CUSHION (UPPER) (ASSY)	
4-370-944-01	CUSHION (LOWER) (ASSY)	
4-370-945-01	INDIVIDUAL CARTON	
4-493-915-21	MANUAL, INSTRUCTION	

♣:1-611-886-11 CN BOARD (PVM-1911 ONLY)

CONNECTOR

- CN11 ♣:1-564-467-11 CONNECTOR (FLAT CABLE) 26P
- CN12 ♣:1-564-466-11 CONNECTOR (FLAT CABLE) 34P
- CN13 ♣:1-561-854-00 SOCKET, CONNECTOR 10P
- CN14 ♣:1-562-457-11 SOCKET, CONNECTOR 14P
- CN15 ♣:1-561-854-00 SOCKET, CONNECTOR 10P
- CN16 ♣:1-562-457-11 SOCKET, CONNECTOR 14P
- CN17 ♣:1-562-457-11 SOCKET, CONNECTOR 14P

MISCELLANEOUS

- △.1-228-482-13 RESISTOR ASSY, HIGH-VOLTAGE
- △.1-451-204-61 DEFLECTION YOKE (SY-108B)
- 1-452-032-00 MAGNET DISK; 10MM ϕ
- 1-452-094-00 MAGNET, ROTATABLE DISK; 15MM ϕ
- △.1-534-517-23 AC CORD
- 1-554-847-11 PANEL, TOUCH (PVM-1911 ONLY)
- 1-557-318-11 CABLE, FLAT 34P (PVM-1911 ONLY)
- 1-557-319-11 CABLE, FLAT 26P (PVM-1911 ONLY)
- 1-557-330-11 CONNECTOR ASSY, CANON 25P (PVM-1911 ONLY)
- L901 △.1-426-087-42 COIL, DEGAUSSING
- S901 △.1-553-584-12 SWITCH, PUSH (POWER)
- SP901 1-503-109-00 SPEAKER
- T502 △.1-439-322-11 TRANSFORMER ASSY, FLYBACK
- V901 △.8-738-706-05 CRT 520SB22A

The components identified by shading and mark △ are critical for safety. Replace only with part number specified.

Les composants identifiés par une trame et une marque △ sont critiques pour la sécurité. Ne les remplacer que par une pièce portant le numéro spécifié.





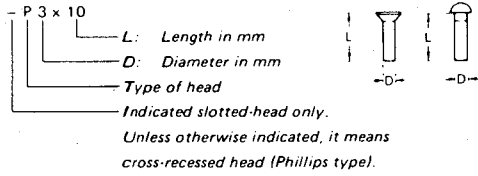



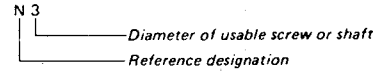



HARDWARE NOMENCLATURE













Screw:



Nut, Washer, Retaining ring:



Reference Designation	Shape	Description	Remarks
SCREWS			
P		pan-head screw	binding-head (B) screw for replacement
PWH		pan-head screw with washer face	binding-head (B) screw and flat washer for replacement
PS PSP		pan-head screw with spring washer	binding-head (B) screw and spring washer for replacement
PSW PSPW		pan-head screw with spring and flat washers	binding-head (B) screw and spring and flat washers for replacement
R		round-head screw	binding-head (B) screw for replacement
K		flat-countersunk-head screw	
RK		oval-countersunk-head screw	
B		binding-head screw	
T		truss-head screw	binding-head (B) screw for replacement
F		flat-filister-head screw	
RF		filister-head screw	
BV		brazier-head screw	

Reference Designation	Shape	Description	Remarks
SELF-TAPPING SCREWS			
TA		self-tapping screw	ex: TA, P 3 x 10
PTP		pan-head self-tapping screw	binding-head self-tapping (TA, B) screw for replacement
PTPWH		pan-head self-tapping screw with washer face	binding-head self-tapping (TA, B) screw and flat washer for replacement
PTTWH		pan-head thread-rolling screw with washer face	binding-head (B) screw and flat washer for replacement
SET SCREWS			
SC		set screw	
SC		hexagon-socket set screw	ex: SC 2.6 x 4, hexagon socket
NUT			
N		nut	
WASHERS			
W		flat washer	
SW		spring washer	
LW		internal-tooth lock washer	ex: LW3, internal
LW		external-tooth lock washer	ex: LW3, external
RETAINING RINGS			
E		retaining ring	
G		grip-type retaining ring	